

USER MANUAL

G-MASTER

LCD Monitor

ENGLISH

G-MASTER GCB3482WQSU
G-MASTER GCB3484WQSU

Thank you very much for choosing the iiyama LCD monitor.

We recommend that you take a few minutes to read this comprehensive manual carefully before installing and switching on the monitor. Please keep this manual in a safe place for your future reference.



Dear user, we congratulate you on the purchase of your iiyama LCD.

For details on warranty and locally used pixel policies that apply directly after installation of your product please check the iiyama website.

To report a fault, please contact your local support centre found at <https://iiyama.com>

Things to check before you call the iiyama information line

- | if the power cable is connected securely and turned on?
- | if the display has been turned on?
- | if the signal cable is connected securely and the correct input selected?
- | if the computer has been restarted with the display connected?
- | if the graphics card is correctly installed with the latest drivers possible?
- | if the correct native resolution has been selected via 'Display Properties'?
- | If the R/G/B signal configuration is correct?
- | if the displays On Screen Menu is shown?
- | if the correct brightness and contrast settings have been set?
- | if given display tolerances and compatibility have been considered?
- | if via the On Screen Menu you have performed a Factory Reset/Recall?

Before reporting the screen defect, please prepare the following information/evidence:

- | model number *
- | purchase receipt and serial number *
- | name and address for collection
- | telephone/fax number, for availability during the day
- | convenient collection date (date, time)
- | short description of the defect

Important Note:

If there is no fault found in the collected equipment after inspection, the transferring party shall incur charges for transport and administration.

If you have checked all of the above and there is still no picture, call our information line for assistance in your country.

Feedback on health and safety issues

If you have any health and safety concerns or questions about the product (including when using the product), please contact iiyama support through our website. You can also contact us by calling +31 204460404. After receiving your feedback, we will ask the responsible unit to handle it as soon as possible and a dedicated person will get back to you. Your feedback will also be recorded and incorporated into our evaluation for improvements

* see the identification plate on the back of the case.

CE MARKING DECLARATION OF CONFORMITY

This LCD monitor complies with the requirements of the EC/EU Directive 2014/30/EU "EMC Directive", 2014/35/EU "Low Voltage Directive", 2009/125/EC "ErP Directive" and 2011/65/EU "RoHS Directive".

The electro-magnetic susceptibility has been chosen at a level that gives correct operation in residential areas, business and light industrial premises and small-scale enterprises, inside as well as outside of the buildings. All places of operation are characterised by their connection to the public low voltage power supply system.

IYAMA CORPORATION: Wijkmeerstraat 8, 2131 HA Hoofddorp, The Netherlands

Model No. : PL3482WQ, PL3484WQ



We recommend recycling of used product. Please contact your dealer or iiyama service center. Recycle information is obtained via the Internet, using the address: <https://iiyama.com>

You can access the Web page of different countries from there.

- We reserve the right to change specifications without notice.
- All trademarks used in this user manual are the property of their respective owners.
- Eprel registration number GCB3482WQSU-B1 : 2234233, GCB3484WQSU-B1 : 2232424

TABLE OF CONTENTS

FOR YOUR SAFETY.....	1
SAFETY PRECAUTIONS.....	1
SPECIAL NOTES ON LCD MONITORS.....	3
CUSTOMER SERVICE.....	3
CLEANING.....	4
BEFORE YOU OPERATE THE MONITOR.....	5
FEATURES.....	5
CHECKING THE CONTENTS OF THE PACKAGE.....	5
USING ARM OR STAND.....	6
FITTING AND REMOVAL OF STAND.....	7
CONTROLS AND CONNECTORS.....	10
CONNECTING YOUR MONITOR.....	11
COMPUTER SETTING.....	12
ADJUSTING THE HEIGHT AND THE VIEWING ANGLE.....	12
OPERATING THE MONITOR.....	13
ADJUSTMENT MENU CONTENTS.....	14
STANDBY FEATURE.....	27
TROUBLE SHOOTING.....	28
RECYCLING INFORMATION.....	29
APPENDIX.....	30
SPECIFICATIONS : G-MASTER GCB3482WQSU-B1.....	30
SPECIFICATIONS : G-MASTER GCB3484WQSU-B1.....	31
DIMENSIONS.....	32
COMPLIANT TIMING.....	32

FOR YOUR SAFETY

SAFETY PRECAUTIONS

WARNING

STOP OPERATING THE MONITOR WHEN YOU SENSE TROUBLE

If you notice any abnormal phenomena such as smoke, strange sounds or fumes, unplug the monitor and contact your dealer or iiyama service center immediately. Further use may be dangerous and can cause fire or electric shock.

NEVER REMOVE THE CABINET

High voltage circuits are inside the monitor. Removing the cabinet may expose you to the danger of fire or electric shock.

DO NOT PUT ANY OBJECT INTO THE MONITOR

Do not put any solid objects or liquids such as water into the monitor. In case of an accident, unplug your monitor immediately and contact your dealer or iiyama service center. Using the monitor with any object inside may cause fire, electric shock or damage.

INSTALL THE MONITOR ON A FLAT, STABLE SURFACE

The monitor may cause an injury if it falls or is dropped.

DO NOT USE THE MONITOR NEAR WATER

Do not use where water may be splashed or spilt onto the monitor as it may cause fire or electric shock.

OPERATE UNDER THE SPECIFIED POWER SUPPLY

Be sure to operate the monitor only with the specified power supply. Use of an incorrect voltage will cause malfunction and may cause fire or electric shock.

PROTECT THE CABLES

Do not pull or bend the power cable and signal cable. Do not place the monitor or any other heavy objects on the cables. If damaged, the cables may cause fire or electric shock.

ADVERSE WEATHER CONDITIONS

It is advisable not to operate the monitor during a heavy thunder storm as the continual breaks in power may cause malfunction. It is also advised not to touch the plug in these circumstances as it may cause electric shock.

CAUTION

INSTALLATION LOCATION

Do not install the monitor where sudden temperature changes may occur, or in humid, dusty or smoky areas as it may cause fire, electric shock or damage. You should also avoid areas where the sun shines directly on the monitor.

DO NOT PLACE THE MONITOR IN A HAZARDOUS POSITION

The monitor may topple and cause injury if not suitably located. Please also ensure that you do not place any heavy objects on the monitor, and that all cables are routed such that children may not pull the cables and possibly cause injury.

CAUTION

MAINTAIN GOOD VENTILATION

Ventilation slots are provided to keep the monitor from overheating. Covering the slots may cause fire. To allow adequate air circulation, place the monitor at least 10cm (or 4 inches) from any walls. When removing the tilt stand, the ventilation slots on the back side of the monitor can be blocked. This may overheat the monitor and may cause fire or damage. Make sure to allow enough ventilation when removing the tilt stand. Operating the monitor on its back, side, upside down or on a carpet or any other soft material may also cause damage.

DISCONNECT THE CABLES WHEN YOU MOVE THE MONITOR

When you move the monitor, turn off the power switch, unplug the monitor and be sure the signal cable is disconnected. If you do not disconnect them, it may cause fire or electric shock.

UNPLUG THE MONITOR

If the monitor is not in use for a long period of time it is recommended that it is left unplugged to avoid accidents.

HOLD THE PLUG WHEN DISCONNECTING

To disconnect the power cable or signal cable, always pull it by the plug. Never pull on the cable itself as this may cause fire or electric shock.

DO NOT TOUCH THE PLUG WITH WET HANDS

Pulling or inserting the plug with wet hands may cause electric shock.

WHEN YOU INSTALL THE MONITOR ON YOUR COMPUTER

Be sure the computer is strong enough to hold the weight of the monitor, otherwise, you may damage your computer.

CAREFUL! PROTECT YOUR HANDS AND FINGERS

- Be careful not to hurt your fingers or hands when you change the height or the angle.
- Injury can occur if care is not taken to avoid finger contact with the displays base when adjusting the height. (Just for height adjustable model.)

REMARK FOR 24/7 USAGE

This product is not specifically designed for 24/7 usage in all environments.

REMARK SPECIFIC TO DESKTOP USE

This product is designed for desktop use, not for digital signage (electronic signboard) applications such as ceiling hanging or wall mounting.

DO NOT TILT THE MONITOR DOWNWARD TOO FAR

To avoid potential screen damage such as LCD panel peeling from the bezel, ensure that the monitor does not tilt downward beyond its adjustable range.

DO NOT USE ALCOHOL OR DISINFECTANTS ON THE MONITOR

Do not spray alcohol or disinfectants directly onto the monitor or use them near the monitor. Also, do not wipe the monitor with a cloth or sheet that contains alcohol or disinfectants. These may cause discoloration, deterioration, or cracking of the cabinet, damage to the surface treatment of the LCD panel, and deterioration of components.

OTHERS

ERGONOMIC RECOMMENDATIONS

To eliminate eye fatigue, do not operate the monitor against a bright background or in a dark room. For optimal viewing comfort, the monitor should be just below eye level and 40-60 cm (16-24 inches) away from your eyes. When using the monitor over a prolonged time, a ten minute break every hour is recommended as looking at the screen continuously can cause eye strain.

SPECIAL NOTES ON LCD MONITORS

The following symptoms are normal with LCD monitors and do not indicate a problem.

NOTE

- When you first turn on the LCD monitor, the picture may not fit in the monitor area because of the type of computer that is used. In this case, adjust the picture position to the correct position.
- You may find slightly uneven brightness on the screen depending on the desktop pattern you use.
- Due to the nature of the LCD screen, an afterimage of the previous screen may remain after switching the image, when the same image is displayed for hours. In this case, the screen can be recovered slowly by changing the image or turning off the Power Switch for some hours.

CUSTOMER SERVICE

NOTE

- If you have to return your unit for service and the original packaging has been discarded, please contact your dealer or iiyama service center for advice or replacement packaging.

CLEANING

WARNING

- If you drop any materials or liquids such as water into the monitor when cleaning, unplug the power cable immediately and contact your dealer or iiyama service center.
- For safety reasons, turn off the power switch and unplug the monitor before you clean it.

CAUTION

- Do not spray alcohol or disinfectants directly onto the monitor or use them near the monitor. Also, do not wipe the monitor with a cloth or sheet that contains alcohol or disinfectants. These may cause discoloration, deterioration, or cracking of the cabinet, damage to the surface treatment of the LCD panel, and deterioration of components.
- To avoid potential damage on the monitor (LCD panel/cabinet/connector terminals) or accessories, never use the following strong solvents or cleaning sheets. These may cause discoloration, deterioration, or cracking of the cabinet, damage to the surface treatment of the LCD panel, and deterioration of components.

Benzine	Hypochlorous acid water
Thinner	Acidic or alkaline solvents
Alcohol	Wax
Bleach	Abrasives
Peroxide	Office equipment cleaner
Acetone	Glass cleaner
Methylene chloride	Tissue paper
Toluene	Wet tissue
Ammonia	Chemical cloth
Sodium hypochlorite solution (Chlorine bleach)	Cleaning paper
	etc.

NOTE

- To protect the LCD panel, do not scratch or rub the screen with a hard object.
- Do not leave the LCD panel wet. If water droplets or the like get on it, immediately wipe it off with a dry, soft cloth. Leaving it on may cause discoloration or stains on the LCD panel. In addition, if moisture gets inside the monitor, it may cause damage.
- Touching the cabinet with any product made from rubber or plastic for a long time may cause degeneration or loss of paint on the cabinet.

Regular care

Gently wipe the cabinet with a soft, dry and clean cloth. If your monitor is particularly dirty, soak the cloth in a mild detergent thoroughly diluted with water, wring it out tightly, and then wipe the dirt off. Then immediately wipe it with a soft, dry cloth.

Alcohol disinfection

Alcohol disinfection may cause discoloration, deterioration, or cracking of the cabinet, damage to the surface treatment of the LCD panel, and deterioration of components. Instead, we recommend disinfecting your hands away from the monitor before and after use.

If you absolutely must disinfect the monitor with alcohol, please understand above warnings and cautions in advance. Also, avoid frequent alcohol disinfection.

BEFORE YOU OPERATE THE MONITOR

FEATURES

- ◆ Supports Resolutions up to 3440 × 1440
- ◆ High Contrast 3000:1 (Typical), Advanced Contrast Function Available, Brightness 500cd/m² (Typical) : G-MASTER GCB3482WQSU
- ◆ High Contrast 4000:1 (Typical), Advanced Contrast Function Available, Brightness 500cd/m² (Typical) : G-MASTER GCB3484WQSU
- ◆ Moving Picture Response Time 0.6ms : G-MASTER GCB3482WQSU
- ◆ Moving Picture Response Time 0.4ms : G-MASTER GCB3484WQSU
- ◆ Supports FreeSync™ Premium Technology
- ◆ Supports HDR400
- ◆ Flicker - Free
- ◆ Blue Light Reducer
- ◆ Digital Character Smoothing
- ◆ 2 × 5W Stereo Speakers
- ◆ Standby Feature
- ◆ VESA Mounting Standard (100mm×100mm) Compliant
- ◆ Keyhole for Security Lock

CHECKING THE CONTENTS OF THE PACKAGE

The following accessories are included in your package. Check to see if they are enclosed with the monitor. If anything is missing or damaged, please contact your local iiyama dealer or regional iiyama office.

- | | |
|------------------------|---------------------------|
| ■ Power Cable* | ■ Stand-Neck |
| ■ HDMI Cable | ■ Stand-Base with a screw |
| ■ DisplayPort Cable | ■ Screwdriver |
| ■ USB Cable (Type-A-B) | ■ Safety Guide |
| ■ VESA Plate | ■ Quick Start Guide |

CAUTION

* All guarantees and warranties are void for any problems or damage caused by a power cable not supplied by iiyama.

An approved power cable greater or equal to H05VVF, 3G, 0.75mm² must be used.

USING ARM OR STAND

CAUTION

- This product is designed for desktop use, not for digital signage (electronic signboard) applications such as ceiling hanging or wall mounting.
- Before installation, make sure the display arm or desk arm stand is strong enough to hold the necessary weight of the monitor and the mount.
- The monitor angle should be within 23° upward and 5° downward. This product cannot be used facing upward or downward beyond this range.
- If the monitor is used (installed) at an angle more than 5° downward, the LCD may peel off from the bezel and fall, resulting in damage. In addition, such cases will not be covered by support or warranty.
- Regularly check the tightness of the screws. If the screws are not tight enough, the monitor may come off and cause injury or damage.

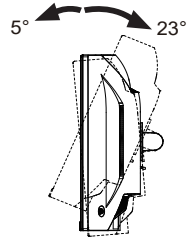

[DISPLAY ARM OR DESK ARM STAND]

CAUTION

- When using a display arm or desk arm stand, consider the thickness of the VESA mounting bracket and use four M4×10mm screws to secure it to the monitor. Ensure all screws are tightened and secured properly. Using screws longer than this may cause electric shock or damage by contacting the electrical parts inside the monitor. For this product, the thickness of the VESA mounting bracket is assumed to be approx. 2.5mm.

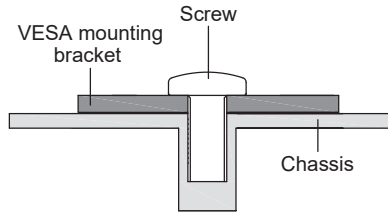

[LANDSCAPE MODE]

This monitor can only be used in landscape. Do not rotate or operate the monitor in any other orientation than landscape.

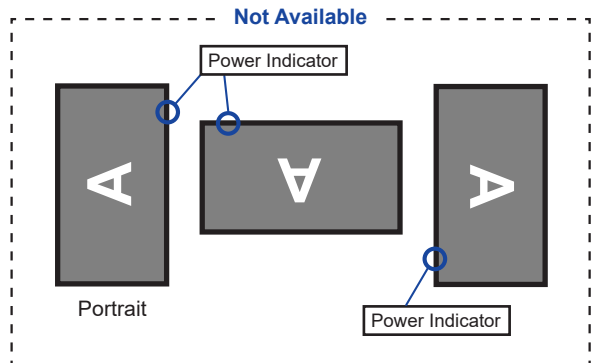
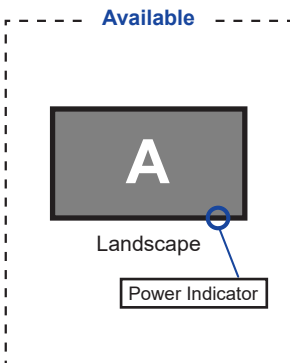

FITTING AND REMOVAL OF STAND

CAUTION

- Put the monitor on a stable surface. The monitor may cause injury or damage if it falls or is dropped.
- Do not give a strong impact to the monitor. It may cause damage.
- Unplug the monitor before removal or installation to avoid an electric shock or a damage.
- Regularly check the tightness of the screws. If the screws are not tight enough, the monitor may come off and cause injury or damage.

<Installation>

- ① As shown below, place all the contents taken out from the carton box on a flat surface with the monitor front face down.
- ② Take off the rear cushion, VESA Plate, Stand-Neck and Stand-Base.

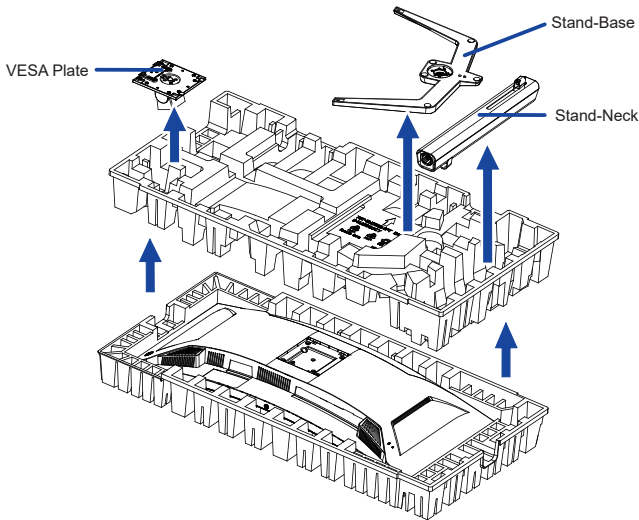

- ③ Attach the Stand-Neck to the VESA Plate and then tighten the 'thumb screw' with the provided screwdriver to secure them.

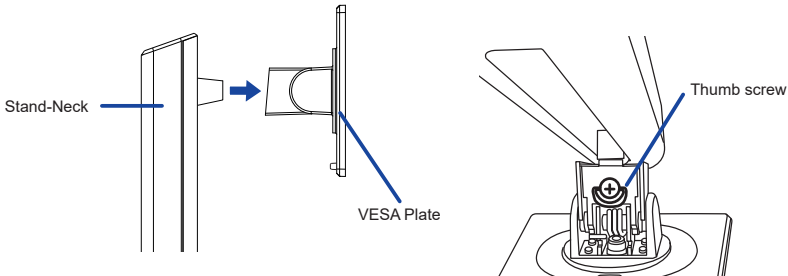

- ④ Install the Stand-Base to the Stand-Neck and then tighten the 'thumb screw' with the provided screwdriver to secure them.

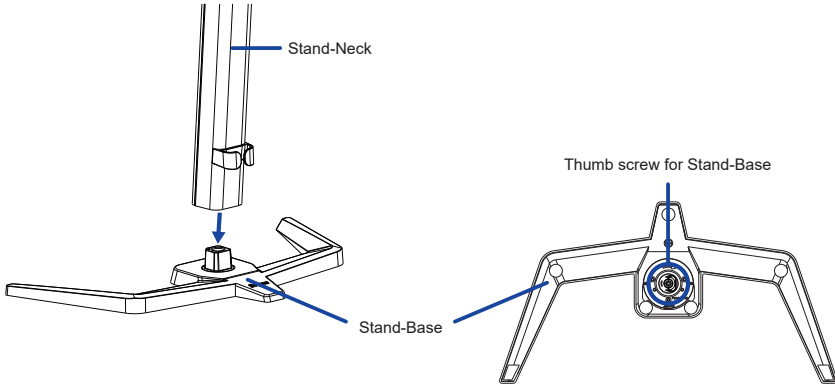

- ⑤ Hold the monitor and install the Stand-Neck to the monitor until it clicks to secure.

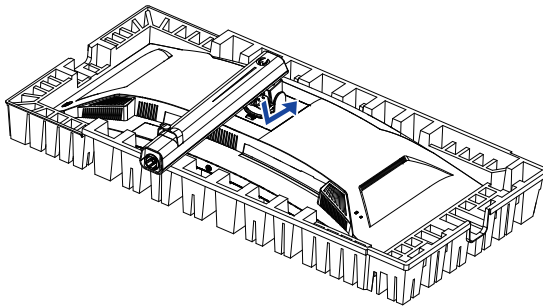

- ⑥ Stand the monitor and then remove the front cushion.

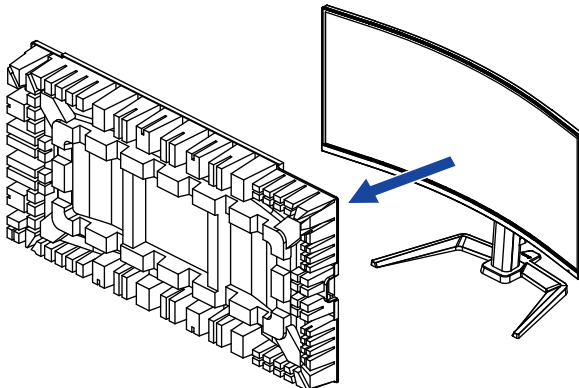

<Removal>

- ① Put the front cushion on a flat surface and place the monitor with face down on it.
- ② Press the release button to remove the stand.

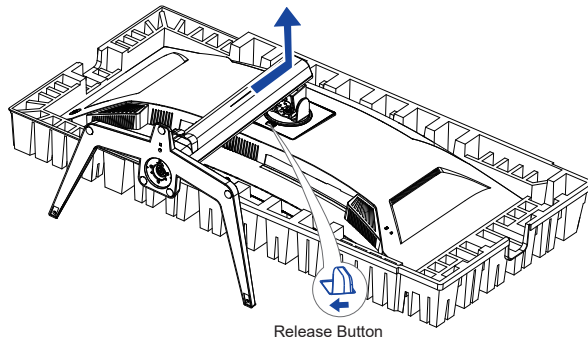

- ③ Loosen the 'thumb screw' with the provided screwdriver to remove the Stand-Neck from the VESA Plate.
- ④ Loosen the 'thumb screw' to remove the Stand-Base from the Stand-Neck.

CONTROLS AND CONNECTORS

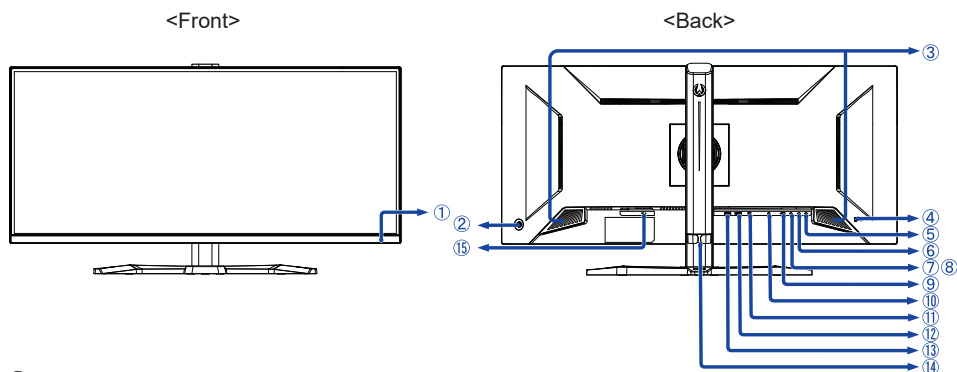

① Power Indicator

NOTE Blue: Normal operation
Orange: Standby mode

② Joystick ()

Power / Menu [Center]

NOTE A short press turns ON the monitor.
A long press for 6 seconds turns OFF the monitor.

Up / Signal Select []

Down []

Left / i-Style Color / Night Mode / Blue Light Reducer [] *1,2

Right / Volume [] *1,2

③ Speakers

④ Keyhole for Security Lock

NOTE You can fasten a security lock and cable to prevent the monitor from being removed without your permission.

⑤ USB Type-C Downstream Connector () (USB3.2 Gen 1: 5Gbps, 5V, 1.5A)

⑥ USB Type-C Downstream Connector () (USB3.2 Gen 1: 5Gbps, 5V, 1.5A)

⑦ USB Type-A Downstream Connector () (USB3.2 Gen 1: 5Gbps, 5V, 900mA)

⑧ USB Type-A Downstream Connector () (USB3.2 Gen 1: 5Gbps, 5V, 900mA)

⑨ USB Type-B Upstream Connector () (USB3.2 Gen 1: 5Gbps)

⑩ Headphone Connector ()

NOTE Proper operation of connected external devices other than headphones is not guaranteed.

⑪ DisplayPort Connector (DP)

⑫ HDMI Connector (HDMI 2)

⑬ HDMI Connector (HDMI 1)

⑭ Cable Holder

⑮ AC Connector (~ : Alternating current)

*1 You can skip the Menu items and directly display an option setting screen or an adjustment scale.

*2 Direction when viewing the screen from the front.

CONNECTING YOUR MONITOR

- ① Ensure that both the computer and the monitor are switched off.
- ② Connect the computer to the monitor with the signal cable.
- ③ Connect the computer to the monitor with the USB Cable.
- ④ Connect the Power Cable to the monitor first and then to the power source.
- ⑤ Turn on your monitor and computer.

NOTE

- Make sure that the building installation has a circuit breaker of 120/240V, 20A (maximum).
- The signal cables used for connecting the computer and monitor may vary with the type of computer used. An incorrect connection may cause serious damage to both the monitor and the computer. The cable supplied with the monitor is for a standard connector. If a special cable is required please contact your local iiyama dealer or regional iiyama office.
- The Class I pluggable equipment Type A must be connected to protective earth.
- The socket-outlet shall be installed near the equipment and shall be easily accessible.
- Excessive sound pressure from ear-/headphones can cause hearing damage/hearing loss.

[Example of Connection]

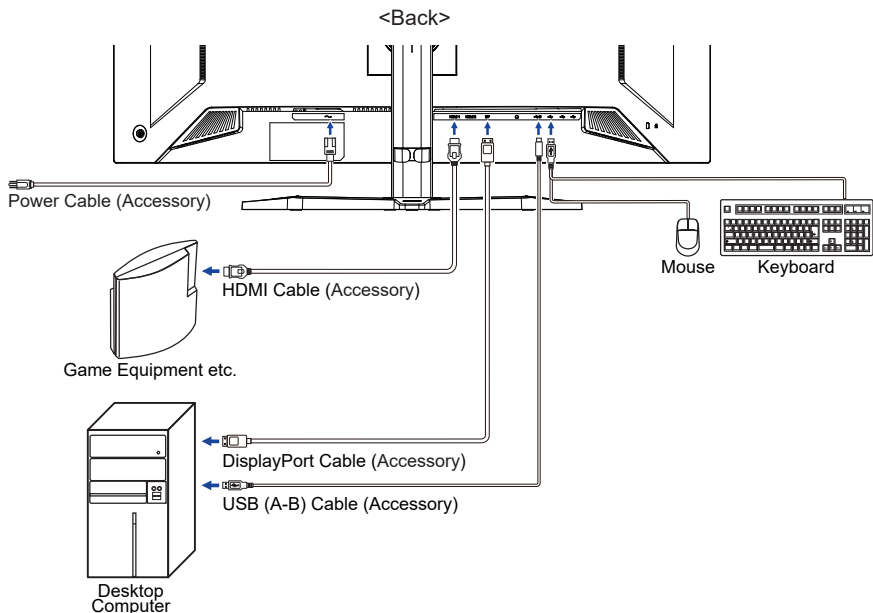

[Collect Cables]

Put the cables through the Cable Holder to bundle them.

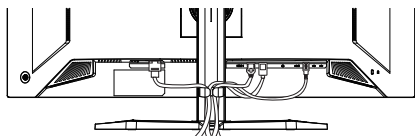

COMPUTER SETTING

■ Signal Timing

Change to the desired signal timing listed on page 32: COMPLIANT TIMING.

ADJUSTING THE HEIGHT AND THE VIEWING ANGLE

- For optimal viewing it is recommended to position yourself directly opposite to the full face of the monitor, then adjust the monitor's height and angle to your own preference.
- Hold the panel so that the monitor does not topple when you change the monitor's height or angle.
- You are able to adjust the monitor's height up to 150mm, angle up to 45° right and left, 23° upward and 5° downward.

NOTE

- Do not touch the LCD screen when you change the height or the angle. It may cause damage or break the LCD screen.
- Careful attention is required not to pinch your fingers or hands into the moving part of the stand when you change the height or the angle.
- Injury can occur if care is not taken to avoid finger contact with the displays base when adjusting the height.

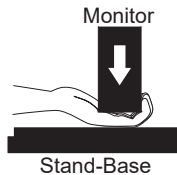
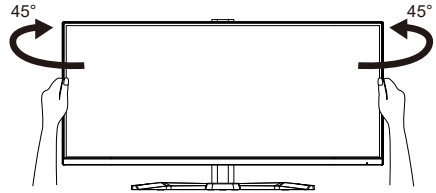
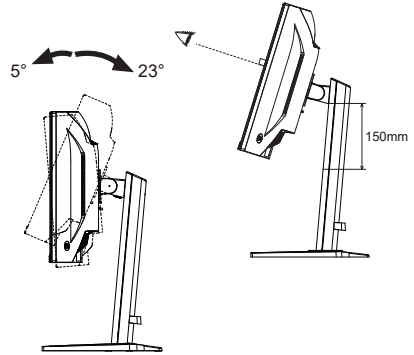

OPERATING THE MONITOR

To create the best picture, your iiyama LCD monitor has been preset at the factory with the COMPLIANT TIMING shown on page 32. You are also able to adjust the picture by following the operation shown below.

- 1 Press the Joystick [Center] on the monitor to start the On Screen Display feature. There are additional Menu items which can be switched by tilting the Joystick [↔/↕].



- 2 Select the Menu item which contains the adjustment icon relating to the adjustment you want to make. Press the Joystick. Then, tilt the Joystick [↕/↔] to highlight the desired adjustment icon.
- 3 Press the Joystick again. Tilt the Joystick [↔/↕] to make the appropriate adjustment or setting.
- 4 Press the Joystick and then tilt it [↔] to leave the menu, and the settings you just made would be automatically saved.

For example, to correct for OSD vertical position, select Menu item of **Setup Menu** and then press the Joystick. Then, select **OSD Vertical Position** by tilting the Joystick [↕/↔]. An adjustment scale becomes active after you press the Joystick. Then, tilt the Joystick [↔/↕] to change the OSD vertical position settings. The OSD vertical position of the overall display should be changing accordingly while you are doing this.

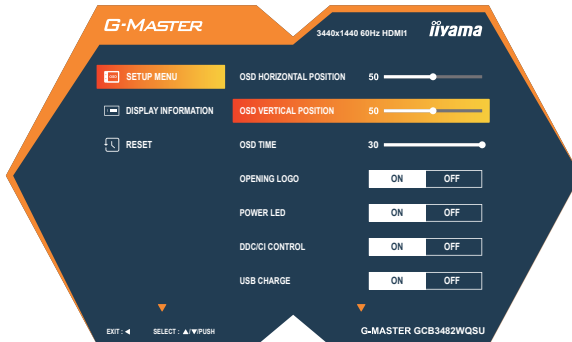

Press the Joystick and finally tilt it [↔] to close the On Screen Display feature. All changes are saved in the memory.















NOTE

- When the Joystick operations are aborted during adjustment, On-Screen Display disappears when the time set for the **OSD Time** has passed. Also, tilting the Joystick [↔] can be used to return previous menu and turn off the On Screen Display.
- Any changes are automatically saved in the memory when the On Screen Display disappears. Turning off the power should be avoided while using the Menu.

ADJUSTMENT MENU CONTENTS

Picture Adjust *1



Adjustment Item	Problem / Option	Joystick
Contrast	Too dull Too intense	   
Brightness *2	Too dark Too bright	   
Overdrive *3	Off / 1 / 2 / 3 / 4 / 5 It will improve the gray level response time of the LCD panel. A higher level results in a faster response time.	 
HDR	On	For HDR (High Dynamic Range) signal
	Off	For normal signal
FreeSync Premium	On	Enable the FreeSync Premium function.
	Off	The FreeSync Premium function is turned off.
Adv. Contrast	On	Increased Contrast Ratio
	Off	Typical Contrast Ratio
Night Mode Direct	Off	Normal
	Mode1	Brightness of back-light is reduced.
	Mode2	Brightness of back-light is reduced more than Mode1.
	Mode3	Brightness of back-light is reduced more than Mode2.
Blue Light Reducer Direct	Off	Typical
	Mode1	Blue light is reduced.
	Mode2	Blue light is reduced more than Mode1.
	Mode3	Blue light is reduced more than Mode2.
Motion Blur Reduction	Off / 1 / 2 / 3 / 4 / 5 / 6 / 7 Reduces motion blur on the LCD panel. Available only when the refresh rate is 100Hz or more.	   
Gamma	1.8	High contrast
	2.2	Normal
	2.6	Dark

*1 Selected adjustments and settings may not be possible due to other items that are enabled. See page 26 **Function Correlation Matrix** for more details.

*2 Adjust the Brightness when you are using the monitor in a dark room and feel the screen is too bright.

*3 Disabled when Direct Drive Mode is not active.

Direct

You can skip the Menu items and directly display an option setting screen by using the following operations.

- Night Mode: Tilt the Joystick Left [↶] when the Menu is not displayed.
- Blue Light Reducer: Tilt the Joystick Left [↶] when the Menu is not displayed.

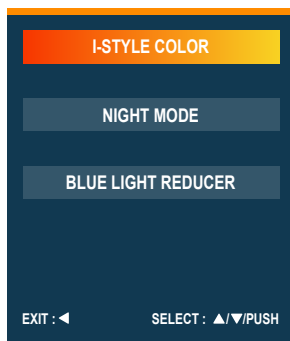

Input Select
Direct



Adjustment Item	Option		
Input Source	Auto	Select the signal input automatically.	
	Manual	HDMI 1	Select the Digital (HDMI 1) input.
		HDMI 2	Select the Digital (HDMI 2) input.
		DP	Select the Digital (DisplayPort) input.
	NOTE		If you manually select one of the input sources, the others are not automatically selected.

Direct

You can skip the Menu items and directly display an option setting screen by using the following operations.

- Input Select: Tilt the Joystick Up [⇧] when the Menu is not displayed, it shows following Menu.

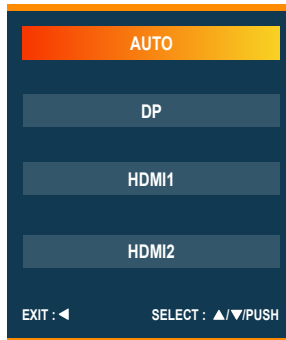



Adjustment Item	Problem / Option	Joystick
Volume Direct	Too soft Too loud	
Mute	On	Turn off the sound temporarily.
	Off	Return the sound volume to the previous level.

Direct

You can skip the Menu items and directly display an adjustment scale by using the following operations.

- Volume: Tilt the Joystick Right [⇨] when the Menu is not displayed.

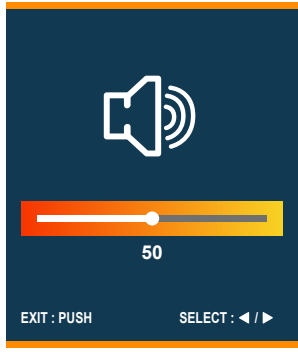



Store User Setting

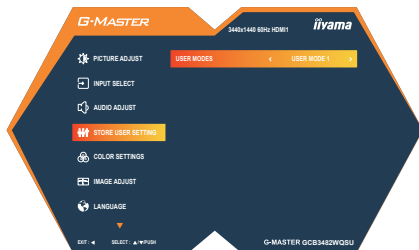

Adjustment Item

Option

User Modes

User Modes 1	Save the settings of the screen adjustment.
User Modes 2	Save the settings of the screen adjustment.
User Modes 3	Save the settings of the screen adjustment.

NOTE





The monitor memorizes your customized settings below. Those settings can be invoked from "i-Style Color" menu of "Image Adjust" later.

Contrast, Brightness, Overdrive, Adv. Contrast, Night Mode, Motion Blur Reduction, Gamma, Volume, Mute, Color Settings, Sharpness, Video Mode Adjust

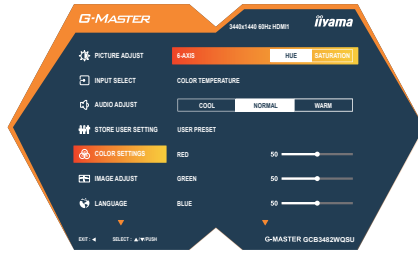

Color Settings *



Adjustment Item	Problem / Option		Joystick
6-Axis	Hue	Red Yellow Green Cyan Blue Magenta	Too weak Too strong 
	Saturation	Red Yellow Green Cyan Blue Magenta	Too weak Too strong 
Color Temperature	Cool	Cool color	
	Normal	Normal color	
	Warm	Warm color	
User Preset	Red	Too weak	
	Green	Too strong	
	Blue		
Black Tuner	From -5 to +5 You can adjust Dark shades.		

* Disabled when Blue Light Reducer or HDR is active.



Adjustment Item	Problem / Option		Joystick
i-Style Color Direct	Off	Return to a state set by color adjustment except i-Style Color.	
	Standard * ¹	For general windows environment and monitor default setting.	
	Sport Game * ¹	For Sports game environment.	
	FPS Game * ¹	For FPS game environment.	
	Strategy Game * ¹	For Strategy game environment.	
	Text * ¹	For text editing and viewing in a word processing environment.	
	User Mode 1	Apply customized monitor settings.	
	User Mode 2	Apply customized monitor settings.	
	User Mode 3	Apply customized monitor settings.	
X-Res Technology * ¹	Off	Normal	
	Soft	Enhance the picture edge.	
	Middle	Enhance the picture edge more than the Soft option.	
	Hard	Enhance the picture edge more than the Middle option.	
Sharpness	1 2 3 4 5 6 You can change the picture quality from 1 to 6 (sharp to soft). Tilt [⇔] to change the picture quality in numerical order. Tilt [⇐] to change the picture quality in reverse numerical order.		
HDMI Range * ²	Full	For full-range color scale signal.	
	Limited	For limited color scale signal.	
Direct Drive Mode * ³	On	Reduce the input-lag.	
	Off	Typical	
NOTE Changing Resolution and Refresh rate or turning Power Off/On might disable the Direct Drive Mode function.			

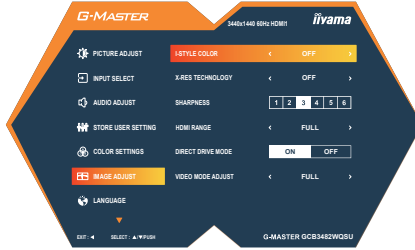

Adjustment Item	Option	
Video Mode Adjust	Full	Expansion display
	Aspect	Expansion display of Aspect
	Dot by Dot * ³	Display the picture dot by dot.
	17inch * ³	Display the picture as 17 inch screen (5 : 4).
	19inch * ³	Display the picture as 19 inch screen (5 : 4).
	19.5inch * ³	Display the picture as 19.5 inch screen (16 : 9).
	21.5inch * ³	Display the picture as 21.5 inch screen (16 : 9).
	23inch * ³	Display the picture as 23 inch screen (16 : 9).
	23.6inch * ³	Display the picture as 23.6 inch screen (16 : 9).
	23.8inch * ³	Display the picture as 23.8 inch screen (16 : 9).
	24inch * ³	Display the picture as 24 inch screen (16 : 9).
24.5inch * ³	Display the picture as 24.5 inch screen (16 : 9).	
27inch * ³	Display the picture as 27 inch screen (16 : 9).	

*¹ Disabled when HDR is active.

*² Available for HDMI input only.

*³ Selected adjustments and settings may not be possible due to other items that are enabled. See page 26 **Function Correlation Matrix** for more details.

Direct

You can skip the Menu items and directly display an option setting screen by using the following operations.

- i-Style Color: Tilt the Joystick Left [⇐] when the Menu is not displayed.

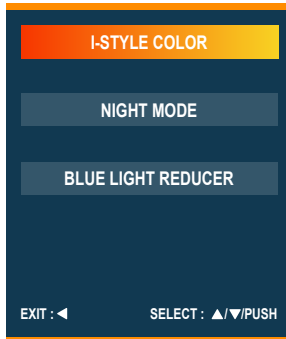



Language

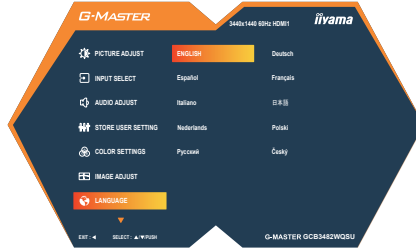

Adjustment Item

Option

Language

English	English	Deutsch	German
Español	Spanish	Français	French
Italiano	Italian	日本語	Japanese
Nederlands	Dutch	Polski	Polish
Русский	Russian	Český	Czech

ENGLISH

Setup Menu

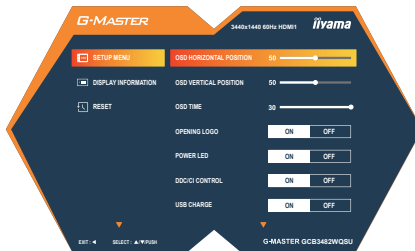

Adjustment Item	Problem / Option	Joystick
OSD Horizontal Position	OSD is too left OSD is too right	
OSD Vertical Position	OSD is too low OSD is too high	
OSD Time	You can set the OSD display duration time between 5 and 30 seconds.	
Opening Logo	On	G-MASTER Logo is displayed when the monitor is turned on.
	Off	G-MASTER Logo is not displayed when the monitor is turned on.
Power LED	On	The Power Indicator is turned On.
	Off	The Power Indicator is turned Off.
	NOTE	Turn Off the Power Indicator when you are bothered by the light.
DDC/CI Control	On	DDC/CI is On.
	Off	DDC/CI is Off.
USB Charge	On	USB devices can be charged even when the monitor is in the standby mode.
	Off	USB devices can not be charged when the monitor is in the standby mode.
	NOTE	When the monitor is turned off, USB devices cannot be charged even when the USB Charge function is on. While this function is off, USB devices do not operate even when the monitor is in standby mode to save standby electricity. When operating USB devices, turn this function on.

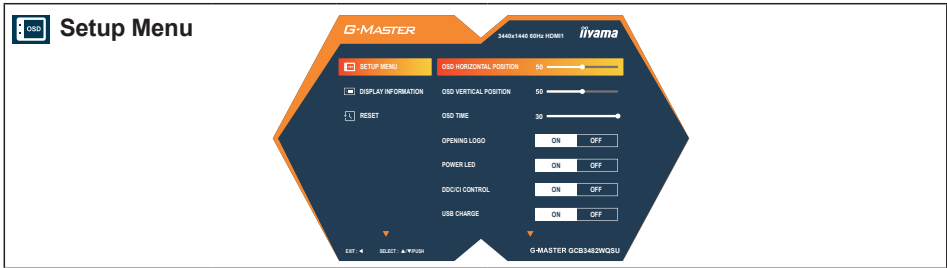

Adjustment Item	Option			
PIP/PBP * ¹	Off	PiP/PbP Mode is turned off.		
	PiP	Display the sub screen in the main screen.		
	PbPLR	Divide display images in Right/Left.		
	Sub Source * ²	HDMI 1	Select the HDMI input for the sub screen.	
		HDMI 2		
		DP		Select the DisplayPort input for the sub screen.
		USB C		Select the USB C input for the sub screen.
	PiP Position * ³	Top-Right	Move the sub screen to the top right corner.	
		Bottom-Right	Move the sub screen to the bottom right corner.	
		Bottom-Left	Move the sub screen to the bottom left corner.	
		Top-Left	Move the sub screen to the top left corner.	
	PiP Size * ³	Small	Reduce the size of the Sub screen.	
		Middle	Normal size of the Sub screen	
		Large	Increase the size of the Sub screen.	
	Swap * ²	No	Return to normal.	
Yes		Swap the Main/Sub screens.		

*¹ PiP = Picture In Picture, With this function, you can display two different pictures.
PbP = Picture By Picture, With this function, you can display max. two different pictures.
Only for G-MASTER GCB3484WQSU

*² Available in "PiP" or "PbP LR" mode.

*³ Available only in "PiP" mode.



Displays information regarding the current input signal coming from the graphic card in your computer.

NOTE See your graphic card user guide for more information about changing the resolution and refresh.



Adjustment Item	Option	
Reset All?	Yes	Factory-preset data is restored.

● **Lock Mode:**

<OSD Menu>

If you turn on the monitor with pressing the Joystick [Center] while the monitor is off, the OSD Menu operations will be locked / unlocked.

<Power Button / OSD Menu>

If you keep pressing the Joystick [Center] for 10 seconds when the Menu is not displayed, the Power Button / OSD Menu operations will be locked / unlocked.

■ **Function Correlation Matrix**

Selected item		Picture Adjust										Color Settings		Image Adjust	
Active item		Contrast	Brightness	Overdrive	Adv. Contrast	Night Mode	Blue Light Reducer	Motion Blur Reduction	Gamma	HDR	FreeSync Premium	Black Tuner	Direct Drive Mode	Video Mode Adjust	Dot by Dot / Display size
				✓	✓	✓	✓	✓	✓	✓	✓	✓	✓	✓	✓
Picture Adjust	Adv. Contrast	✓	✓	✓	✓	✓	✓	✓	✓	✓	✓	✓	✓	✓	✓
	Night Mode	✓	–	✓	✓	–	–	–	–	–	–	–	–	–	–
	Blue Light Reducer	✓	✓	✓	✓	–	–	–	–	–	–	–	–	–	–
	Motion Blur Reduction	✓	–	–	–	–	–	–	–	–	–	–	–	–	–
	HDR	–	–	✓	–	–	–	–	–	–	–	–	–	–	–
	FreeSync Premium	✓	✓	✓	–	✓	✓	✓	✓	✓	✓	✓	✓	✓	✓
Color Settings	Black Tuner	✓	✓	✓	✓	✓	✓	✓	✓	✓	✓	✓	✓	✓	✓
	I-Style Color (All presets)	–	–	–	–	–	–	–	–	–	–	–	–	–	–
Image Adjust	Direct Drive Mode	✓	✓	✓	✓	✓	✓	✓	✓	✓	✓	✓	✓	✓	✓
	Full / Aspect	✓	✓	✓	✓	✓	✓	✓	✓	✓	✓	✓	✓	✓	✓
	Video Mode Adjust	✓	✓	✓	✓	✓	✓	✓	✓	✓	✓	✓	✓	✓	✓
	Dot by Dot / Display size	✓	✓	–	✓	✓	✓	✓	✓	–	–	–	–	–	–

✓ : Available

– : Not available

STANDBY FEATURE

This product features the standby function. When activated, it automatically reduces unnecessary power consumption of the monitor when your computer is not in use.

There is a standby step the monitor takes as described below. The standby function, including any timer settings is configured by the operating system. Check your operating system manual for information on how this can be configured.

■ Standby Mode

When the video signal from the computer is off, the monitor enters into Standby Mode which reduces the power consumption to 0.5W or less. The screen becomes dark, and the power indicator turns to orange. From Standby Mode, the image reappears in several seconds when either the keyboard or the mouse are touched again.

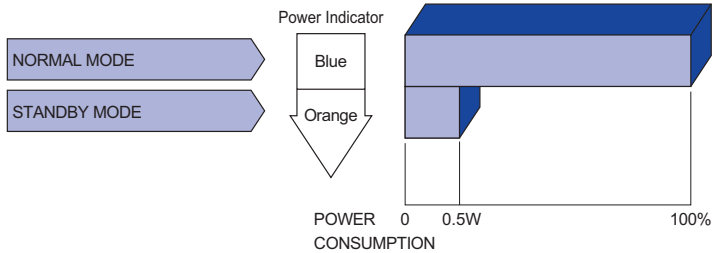

TROUBLE SHOOTING

If the monitor fails to operate correctly, please follow the steps below for a possible solution.

1. Perform the adjustments described in OPERATING THE MONITOR, depending on the problem you have. If the monitor does not get a picture, skip to 2.
2. Consult the following items if you cannot find an appropriate adjustment item in OPERATING THE MONITOR or if the problem persists.
3. If you are experiencing a problem which is not described below or you cannot correct the problem, discontinue using the monitor and contact your dealer or iiyama service center for further assistance.

Problem	Check
① The picture does not appear. (Power indicator does not light up.) (Power indicator is blue.) (Power indicator is orange.)	<input type="checkbox"/> The Power Cable is firmly seated in the socket. <input type="checkbox"/> The Power Button is turned ON. <input type="checkbox"/> The AC socket is live. Please check with another piece of equipment. <input type="checkbox"/> If the blank screen saver is in active mode, touch the keyboard or the mouse. <input type="checkbox"/> Increase the Contrast and/or Brightness. <input type="checkbox"/> The computer is ON. <input type="checkbox"/> The Signal Cable is properly connected. <input type="checkbox"/> The signal timing of the computer is within the specification of the monitor. <input type="checkbox"/> If the monitor is in standby mode, touch the keyboard or the mouse. <input type="checkbox"/> The computer is ON. <input type="checkbox"/> The Signal Cable is properly connected. <input type="checkbox"/> The signal timing of the computer is within the specification of the monitor.
② The screen is not synchronized.	<input type="checkbox"/> The Signal Cable is properly connected. <input type="checkbox"/> The signal timing of the computer is within the specification of the monitor.
③ The screen position is not in the center.	<input type="checkbox"/> The signal timing of the computer is within the specification of the monitor.
④ The screen is too bright or too dark.	<input type="checkbox"/> The video output level of the computer is within the specification of the monitor.
⑤ The screen is shaking.	<input type="checkbox"/> The power voltage is within the specification of the monitor. <input type="checkbox"/> The signal timing of the computer is within the specification of the monitor.
⑥ No sound.	<input type="checkbox"/> The audio equipment (computer etc.) is ON. <input type="checkbox"/> The Volume is turned up. <input type="checkbox"/> The Mute is OFF. <input type="checkbox"/> The audio output level of the audio equipment is within the specification of the monitor.
⑦ The sound is too loud or too quiet.	<input type="checkbox"/> The audio output level of the audio equipment is within the specification of the monitor.

RECYCLING INFORMATION

For better environment protection please don't dispose your monitor.
Please visit our web site: <https://iiyama.com> for monitor recycling.

APPENDIX

Design and specifications are subject to change without prior notice.

SPECIFICATIONS : G-MASTER GCB3482WQSU-B1

ENGLISH

Size Category	34"	
LCD Panel	Panel technology	VA
	Size	Diagonal: 34" (86.4cm)
	Curvature	1500R
	Pixel pitch	0.23175mm H × 0.23175mm V
	Brightness	500cd/m ² (Typical), 170cd/m ² (Default / Energy Saving)
	Contrast ratio	3000 : 1 (Typical), Advanced Contrast Function Available
	Viewable angle	Right / Left: 89° each, Up / Down: 89° each (Typical)
	MPRT	0.6ms
Display Colors	Approx. 16.7M	
Sync Frequency	HDMI: Horizontal: 30.0-180.0kHz Vertical: 50-120Hz (2560 × 1440 or less) 50-100Hz (3440 × 1440) DisplayPort: Horizontal: 30.0-180.0kHz Vertical: 48-120Hz	
Native Resolution	3440 × 1440, 4.9 MegaPixels	
Supported max. resolution	HDMI: 2560 × 1440 120Hz 3440 × 1440 100Hz DisplayPort: 3440 × 1440 120Hz	
Input Connector	HDMI × 2, DisplayPort × 1	
Input Video Signal	HDMI, DisplayPort	
USB Standard	USB3.2 Gen 1 (5Gbps, DC5V, 900mA), USB Power Delivery (7.5W)	
Number of USB Ports	1 Upstream: Type-B × 1	
Connector shape	4 Downstream: Type-A × 2, Type-C × 2	
Headphone Connector *	ø 3.5mm mini jack (Stereo)	
Speakers	5W × 2 (Stereo speakers)	
Maximum Screen Size	797.22mm W × 333.72mm H / 31.4" W × 13.1" H	
Power Source	100-240VAC, 50/60Hz, 1.5A	
Power Consumption	50W (Typical), 26W (Default / Energy Saving) Standby mode: 0.5W maximum, Off mode: 0.3W maximum	
Dimensions	808.0 × 433.0 - 578.0 × 290.0mm / 31.8 × 17.0 - 22.7 × 11.4" (W×H×D)	
Net Weight	8.5kg / 18.7lbs	
Height Adjustment Range	150mm	
Angle	Tilt: Upward: 23°, Downward: 5° Swivel: Left / Right: 45° each	
Environmental Considerations	Operating: Temperature 5 to 35°C / 41 to 95°F Humidity 10 to 90% (No condensation) Storage: Temperature -20 to 60°C / -4 to 140°F Humidity 10 to 90% (No condensation)	
EPEAT Bronze	Visit www.epeat.net for the registration status in your country	
Approvals	CE, UKCA, TÜV-GS, EAC, VCCI, PSE	

NOTE * Proper operation of connected external devices other than headphones is not guaranteed.

SPECIFICATIONS : G-MASTER GCB3484WQSU-B1

Size Category	34"	
LCD Panel	Panel technology	VA
	Size	Diagonal: 34" (86.4cm)
	Curvature	1500R
	Pixel pitch	0.23175mm H × 0.23175mm V
	Brightness	500cd/m ² (Typical), 170cd/m ² (Default / Energy Saving)
	Contrast ratio	4000 : 1 (Typical), Advanced Contrast Function Available
	Viewable angle	Right / Left: 89° each, Up / Down: 89° each (Typical)
	MPRT	0.4ms
Display Colors	Approx. 16.7M	
Sync Frequency	HDMI: Horizontal: 30.0-185.0kHz Vertical: 48-120Hz (2560 × 1440 or less) 50-100Hz (3440 × 1440) DisplayPort: Horizontal: 30.0-283.0kHz Vertical: 48-180Hz	
Native Resolution	3440 × 1440, 4.9 MegaPixels	
Supported max. resolution	HDMI: 2560 × 1440 120Hz 3440 × 1440 100Hz DisplayPort: 3440 × 1440 180Hz	
Input Connector	HDMI × 2, DisplayPort × 1	
Input Video Signal	HDMI, DisplayPort	
USB Standard	USB3.2 Gen 1 (5Gbps, DC5V, 900mA), USB Power Delivery (7,5W))	
Number of USB Ports	1 Upstream: Type-B × 1	
Connector shape	4 Downstream: Type-A × 2, Type-C × 2	
Headphone Connector *	ø 3.5mm mini jack (Stereo)	
Speakers	5W × 2 (Stereo speakers)	
Maximum Screen Size	797.22mm W × 333.72mm H / 31.4" W × 13.1" H	
Power Source	100-240VAC, 50/60Hz, 1.5A	
Power Consumption	60W (Typical), 32W (Default / Energy Saving) Standby mode: 0.5W maximum, Off mode: 0.3W maximum	
Dimensions	808.0 × 433.0 - 578.0 × 290.0mm / 31.8 × 17.0 - 22.7 × 11.4" (W×H×D)	
Net Weight	8.5kg / 18.7lbs	
Height Adjustment Range	150mm	
Angle	Tilt: Upward: 23°, Downward: 5° Swivel: Left / Right: 45° each	
Environmental Considerations	Operating: Temperature 5 to 35°C / 41 to 95°F Humidity 10 to 90% (No condensation) Storage: Temperature -20 to 60°C / -4 to 140°F Humidity 10 to 90% (No condensation)	
EPEAT Bronze	Visit www.epeat.net for the registration status in your country	
Approvals	CE, UKCA, TÜV-GS, EAC, VCCI, PSE	

NOTE * Proper operation of connected external devices other than headphones is not guaranteed.

DIMENSIONS

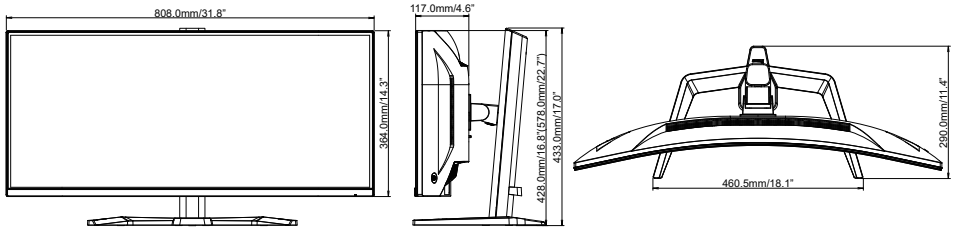

() : Maximum adjustment range

COMPLIANT TIMING

Video Mode	Horizontal Frequency	Vertical Frequency	Dot Clock
800 × 600	37.879kHz	60.317Hz	40.000MHz
	46.875kHz	75.000Hz	49.500MHz
1024 × 768	48.363kHz	60.004Hz	65.000MHz
	60.023kHz	75.029Hz	78.750MHz
1280 × 1024	63.981kHz	60.020Hz	108.000MHz
	79.976kHz	75.025Hz	135.000MHz
1920 × 1080	67.500kHz	60.000Hz	148.500MHz
	135.000kHz	120.000Hz	297.000MHz
2560 × 1440	88.787kHz	59.951Hz	241.500MHz
	183.000kHz	120.000Hz	497.750MHz
3440 × 1440	88.860kHz	60.000Hz	319.896MHz
	151.000kHz	100.000Hz	567.760MHz
	180.000kHz	120.000Hz	676.800MHz
	247.500kHz	165.000Hz	910.800MHz
	265.680kHz	180.000Hz	943.260MHz

*2

*2

*1

*3

*3

NOTE *1 Available for DisplayPort input only.

*2 Available for HDMI input only.

*3 Available for G-MASTER GCB3484WQSU-B1 DisplayPort input only.

Console	1080p (1920×1080)	1440p (2560×1440)	2160p (3840×2160)
PS5	60 / 120Hz	60 / 120Hz	60Hz
Xbox Series X/S	60 / 120Hz	60 / 120Hz	60Hz *

* Available for Xbox Series X only.