

USER MANUAL

ProLite

LCD Monitor

ENGLISH

ProLite B2083HSD
ProLite E2083HSD

Thank you very much for choosing the iiyama LCD monitor.

We recommend that you take a few minutes to read this comprehensive manual carefully before installing and switching on the monitor. Please keep this manual in a safe place for your future reference.



Dear user, we congratulate you on the purchase of your iiyama LCD.

For details on warranty and locally used pixel policies that apply directly after installation of your product please check the iiyama website.

To report a fault, please contact your local support centre found at www.iiyama.com/service

Things to check before you call the iiyama information line

- | if the power cable is connected securely and turned on?
- | if the display has been turned on?
- | if the signal cable is connected securely and the correct input selected?
- | if the computer has been restarted with the display connected?
- | if the graphics card is correctly installed with the latest drivers possible?
- | if the correct native resolution has been selected via 'Display Properties'?
- | If the R/G/B signal configuration is correct?
- | if the displays On Screen Menu is shown?
- | if the correct brightness and contrast settings have been set?
- | if given display tolerances and compatibility have been considered?
- | if via the On Screen Menu you have performed a Factory Reset/Recall?

Before reporting the screen defect, please prepare the following information/evidence:

- | model number *
- | purchase receipt and serial number *
- | name and address for collection
- | telephone/fax number, for availability during the day
- | convenient collection date (date, time)
- | short description of the defect

Important Note:

If there is no fault found in the collected equipment after inspection, the transferring party shall incur charges for transport and administration.

If you have checked all of the above and there is still no picture, call our information line for assistance in your country.

* see the identification plate on the back of the case.

CE MARKING DECLARATION OF CONFORMITY

This LCD monitor complies with the requirements of the EC/EU Directive 2014/30/EU "EMC Directive", 2014/35/EU "Low Voltage Directive", 2009/125/EC "ErP Directive" and 2011/65/EU "RoHS Directive".

The electro-magnetic susceptibility has been chosen at a level that gives correct operation in residential areas, business and light industrial premises and small-scale enterprises, inside as well as outside of the buildings. All places of operation are characterised by their connection to the public low voltage power supply system.

IYAMA CORPORATION: Wijkemeerstraat 8, 2131 HA Hoofddorp, The Netherlands

Model No. : PL2083H



We recommend recycling of used product. Please contact your dealer or iiyama service center. Recycle information is obtained via the Internet, using the address: <http://www.iiyama.com>

You can access the Web page of different countries from there.

- We reserve the right to change specifications without notice.
- All trademarks used in this user manual are the property of their respective owners.
- Eprel registration number : ProLite B2083HSD-B1 C: 362571, ProLite E2083HSD-B1: 362484

TABLE OF CONTENTS

FOR YOUR SAFETY.....	1
SAFETY PRECAUTIONS.....	1
SPECIAL NOTES ON LCD MONITORS.....	3
CUSTOMER SERVICE.....	3
CLEANING.....	3
BEFORE YOU OPERATE THE MONITOR.....	4
FEATURES.....	4
CHECKING THE CONTENTS OF THE PACKAGE.....	4
INSTALLATION.....	5
FITTING AND REMOVAL OF BASE : ProLite B2083HSD.....	7
FITTING AND REMOVAL OF BASE : ProLite E2083HSD.....	8
CONTROLS AND CONNECTORS : ProLite B2083HSD.....	9
CONTROLS AND CONNECTORS : ProLite E2083HSD.....	10
CONNECTING YOUR MONITOR : ProLite B2083HSD.....	11
CONNECTING YOUR MONITOR : ProLite E2083HSD.....	12
COMPUTER SETTING.....	13
ADJUSTING THE VIEWING ANGLE : ProLite E2083HSD.....	13
ADJUSTING THE HEIGHT AND THE VIEWING ANGLE :	
ProLite B2083HSD.....	14
OPERATING THE MONITOR.....	15
ADJUSTMENT MENU CONTENTS.....	16
SCREEN ADJUSTMENTS.....	22
STANDBY FEATURE.....	25
TROUBLE SHOOTING.....	26
RECYCLING INFORMATION.....	27
APPENDIX.....	28
SPECIFICATIONS : ProLite B2083HSD.....	28
SPECIFICATIONS : ProLite E2083HSD.....	29
DIMENSIONS : ProLite B2083HSD.....	30
DIMENSIONS : ProLite E2083HSD.....	30
COMPLIANT TIMING.....	31

FOR YOUR SAFETY

SAFETY PRECAUTIONS

WARNING

STOP OPERATING THE MONITOR WHEN YOU SENSE TROUBLE

If you notice any abnormal phenomena such as smoke, strange sounds or fumes, unplug the monitor and contact your dealer or iiyama service center immediately. Further use may be dangerous and can cause fire or electric shock.

NEVER REMOVE THE CABINET

High voltage circuits are inside the monitor. Removing the cabinet may expose you to the danger of fire or electric shock.

DO NOT PUT ANY OBJECT INTO THE MONITOR

Do not put any solid objects or liquids such as water into the monitor. In case of an accident, unplug your monitor immediately and contact your dealer or iiyama service center. Using the monitor with any object inside may cause fire, electric shock or damage.

INSTALL THE MONITOR ON A FLAT, STABLE SURFACE

The monitor may cause an injury if it falls or is dropped.

DO NOT USE THE MONITOR NEAR WATER

Do not use where water may be splashed or spilt onto the monitor as it may cause fire or electric shock.

OPERATE UNDER THE SPECIFIED POWER SUPPLY

Be sure to operate the monitor only with the specified power supply. Use of an incorrect voltage will cause malfunction and may cause fire or electric shock.

PROTECT THE CABLES

Do not pull or bend the power cable and signal cable. Do not place the monitor or any other heavy objects on the cables. If damaged, the cables may cause fire or electric shock.

ADVERSE WEATHER CONDITIONS

It is advisable not to operate the monitor during a heavy thunder storm as the continual breaks in power may cause malfunction. It is also advised not to touch the plug in these circumstances as it may cause electric shock.

CAUTION

INSTALLATION LOCATION

Do not install the monitor where sudden temperature changes may occur, or in humid, dusty or smoky areas as it may cause fire, electric shock or damage. You should also avoid areas where the sun shines directly on the monitor.

DO NOT PLACE THE MONITOR IN A HAZARDOUS POSITION

The monitor may topple and cause injury if not suitably located. Please also ensure that you do not place any heavy objects on the monitor, and that all cables are routed such that children may not pull the cables and possibly cause injury.

MAINTAIN GOOD VENTILATION

Ventilation slots are provided to keep the monitor from overheating. Covering the slots may cause fire. To allow adequate air circulation, place the monitor at least 10 cm (or 4 inches) from any walls. When removing the tilt stand, the ventilation slots on the back side of the monitor can be blocked. This may overheat the monitor and may cause fire or damage. Make sure to allow enough ventilation when removing the tilt stand. Operating the monitor on its back, side, upside down or on a carpet or any other soft material may also cause damage.

DISCONNECT THE CABLES WHEN YOU MOVE THE MONITOR

When you move the monitor, turn off the power switch, unplug the monitor and be sure the signal cable is disconnected. If you do not disconnect them, it may cause fire or electric shock.

UNPLUG THE MONITOR

If the monitor is not in use for a long period of time it is recommended that it is left unplugged to avoid accidents.

HOLD THE PLUG WHEN DISCONNECTING

To disconnect the power cable or signal cable, always pull it by the plug. Never pull on the cable itself as this may cause fire or electric shock.

DO NOT TOUCH THE PLUG WITH WET HANDS

Pulling or inserting the plug with wet hands may cause electric shock.

WHEN YOU INSTALL THE MONITOR ON YOUR COMPUTER

Be sure the computer is strong enough to hold the weight of the monitor, otherwise, you may damage your computer.

CAREFUL! PROTECT YOUR HANDS AND FINGERS

- Be careful not to hurt your fingers or hands when you change the height or the angle.
- Injury can occur if care is not taken to avoid finger contact with the displays base when adjusting the height. (Just for height adjustable model.)

REMARK FOR 24/7 USAGE

This product is not specifically designed for 24/7 usage in all environments.

OTHERS

ERGONOMIC RECOMMENDATIONS

To eliminate eye fatigue, do not operate the monitor against a bright background or in a dark room. For optimal viewing comfort, the monitor should be just below eye level and 40-60 cm (16-24 inches) away from your eyes. When using the monitor over a prolonged time, a ten minute break every hour is recommended as looking at the screen continuously can cause eye strain.

SPECIAL NOTES ON LCD MONITORS

The following symptoms are normal with LCD monitors and do not indicate a problem.

NOTE

- When you first turn on the LCD monitor, the picture may not fit in the display area because of the type of computer that is used. In this case, adjust the picture position to the correct position.
- You may find slightly uneven brightness on the screen depending on the desktop pattern you use.
- Due to the nature of the LCD screen, an afterimage of the previous screen may remain after switching the image, when the same image is displayed for hours. In this case, the screen can be recovered slowly by changing the image or turning off the Power Switch for some hours.

CUSTOMER SERVICE

NOTE

- If you have to return your unit for service and the original packaging has been discarded, please contact your dealer or iiyama service center for advice or replacement packaging.

CLEANING

WARNING

- If you drop any materials or liquids such as water into the monitor when cleaning, unplug the power cable immediately and contact your dealer or iiyama service center.

CAUTION

- For safety reasons, turn off the power switch and unplug the monitor before you clean it.

NOTE

- To protect the LCD panel, do not scratch or rub the screen with a hard object.
- Never use any of the following strong solvents. These will damage the cabinet and the LCD screen.

Thinner	Spray-type cleaner
Benzine	Wax
Abrasive cleaner	Acid or Alkaline solvent

- Touching the cabinet with any product made from rubber or plastic for a long time may cause degeneration or loss of paint on the cabinet.

CABINET

Stains can be removed with a cloth lightly moistened with a mild detergent solvent. Then wipe the cabinet with a soft dry cloth.

LCD

Periodic cleaning with a soft dry cloth is recommended.

SCREEN

Don't use tissue paper etc. because these will damage the LCD screen.

BEFORE YOU OPERATE THE MONITOR

FEATURES

- ◆ Supports Resolutions up to 1600 × 900
- ◆ High Contrast 1000:1 (Typical), Adv. Contrast Function Available / Brightness 250cd/m² (Typical)
- ◆ Quick Response Time 5ms (Typical)
- ◆ Blue Light Reducer
- ◆ Digital Character Smoothing
- ◆ Automatic Set-up
- ◆ Stereo Speakers
2 × 1W Stereo Speakers
- ◆ Plug & Play VESA DDC2B Compliant
Windows® 7/8.1/10 Compliant
- ◆ Standby Feature (VESA DPMS Compliant)
- ◆ VESA Mounting Standard (100mm×100mm) Compliant
- ◆ Keyhole for Security Lock

CHECKING THE CONTENTS OF THE PACKAGE

The following accessories are included in your package. Check to see if they are enclosed with the monitor. If anything is missing or damaged, please contact your local iiyama dealer or regional iiyama office.

- | | | |
|-----------------------------|-----------------------|---|
| ■ Power Cable* ¹ | ■ DVI-D Cable | ■ Audio Cable |
| ■ Stand-Base* ² | ■ Stand* ² | ■ Stand-Base with a screw* ³ |
| ■ Safety Guide | ■ Quick Start Guide | |

CAUTION

*¹ The rating of the Power Cable enclosed in 120V area is 10A/125V. If you are using a power supply higher than this rating, then a power cable with a rating of 10A/250V must be used. However, all guarantees and warranties are void for any problems or damage caused by a power cable not supplied by iiyama.
An approved power cable greater or equal to H05VVF, 3G, 0.75mm² must be used.

*² Accessory for ProLite E2083HSD.

*³ Accessory for ProLite B2083HSD.

INSTALLATION

- WARNING** ■ Before installation, make sure the wall, ceiling or desktop arm is strong enough to hold the necessary weight of the display and the mount.

< WALL MOUNTING >

- WARNING** ■ When you use with the wall mounting, in consideration of thickness of the mounting stage, tighten the M4 Screws (4pcs) with washer which "L" length is 7mm to fasten the monitor. Using the screw longer than this may cause electric shock or damage because it may contact with the electrical parts inside the monitor.

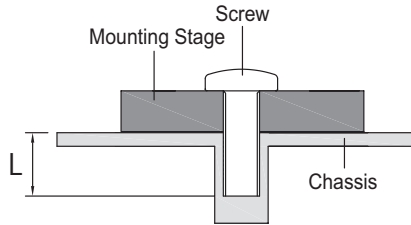

< ROTATING THE DISPLAY >

• ProLite B2083HSD

The monitor is designed to be compatible with both landscape and portrait modes.
Video card for portrait display will be required for rotating the image on the screen.

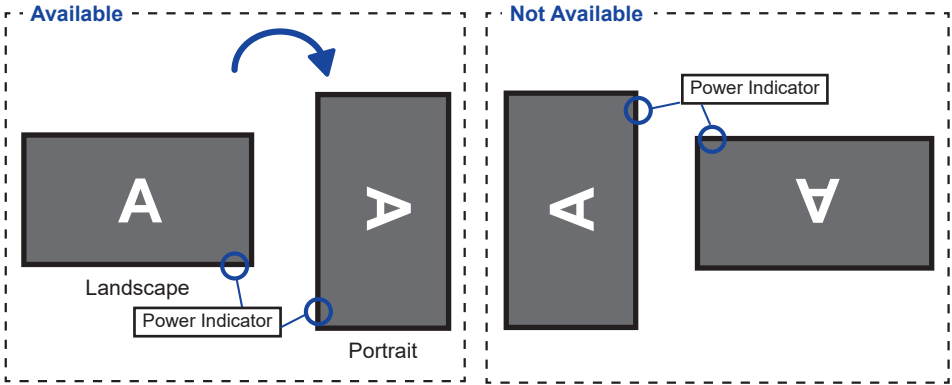

With Stand:

NOTE

- Adjust the monitor's height before panel rotation.
- Attempting to rotate the panel forcibly without adjusting the stand height may cause damage to the panel or the stand.

• ProLite E2083HSD

It is designed to be compatible in landscape mode.

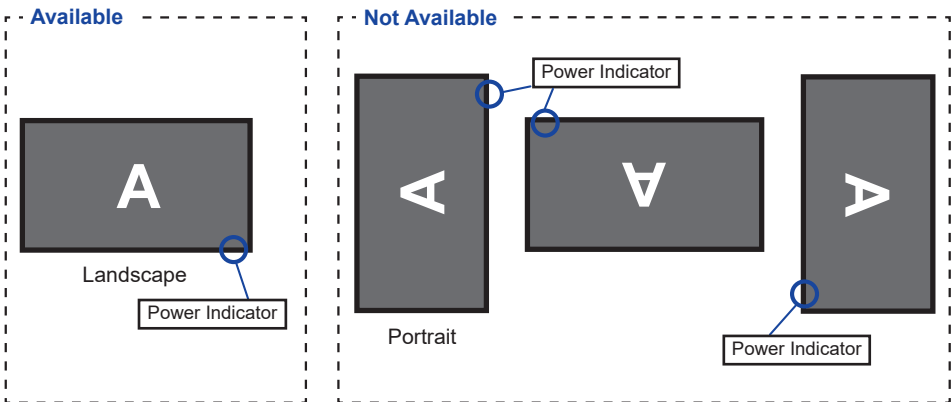

FITTING AND REMOVAL OF BASE : ProLite B2083HSD

CAUTION

- Put the monitor on a stable surface. The monitor may cause injury or damage if it falls or is dropped.
- Do not give a strong impact to the monitor. It may cause damage.
- Unplug the monitor before removal or installation to avoid an electric shock or a damage.

<Installation>

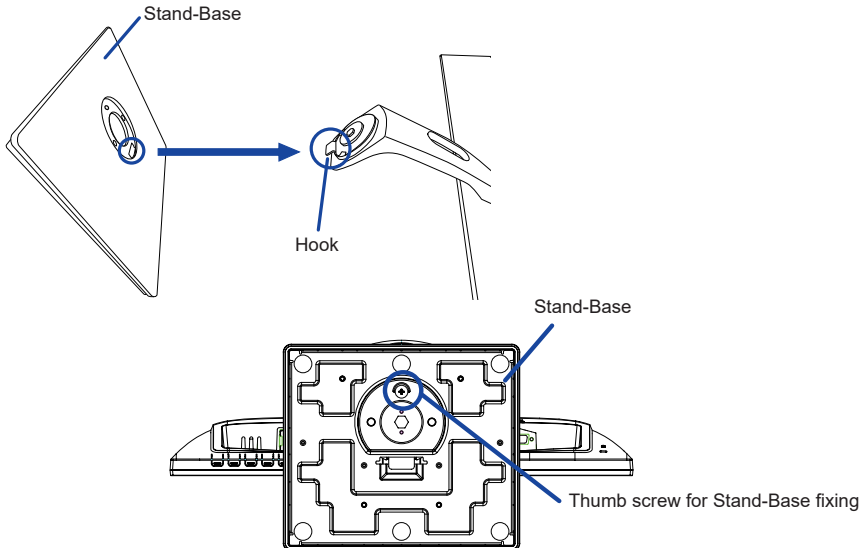

- ① Put a piece of soft cloth on the table beforehand to prevent the monitor from being scratched. Lay the monitor flat on a table with front face down.
- ② Install the stand-base as shown on above picture.
- ③ Use the 'thumb screw' provided to secure the base to the monitor.

<Removal>

- ① Put a piece of soft cloth on the table beforehand to prevent the monitor from being scratched. Lay the monitor flat on a table with front face down.
- ② Loosen the 'thumb screw' to remove the Stand-Base from the monitor.

FITTING AND REMOVAL OF BASE : ProLite E2083HSD

CAUTION

- Put the monitor on a stable surface. The monitor may cause injury or damage if it falls or is dropped.
- Do not give a strong impact to the monitor. It may cause damage.
- Unplug the monitor before removal or installation to avoid an electric shock or a damage.

<Installation>

- ① Put a piece of soft cloth on the table beforehand to prevent the monitor from being scratched. Lay the monitor flat on a table with front face down.
- ② Hold the monitor and install the Stand until it clicks and is secure.
- ③ Hold the monitor and install the Stand-Base until it clicks and is secure.

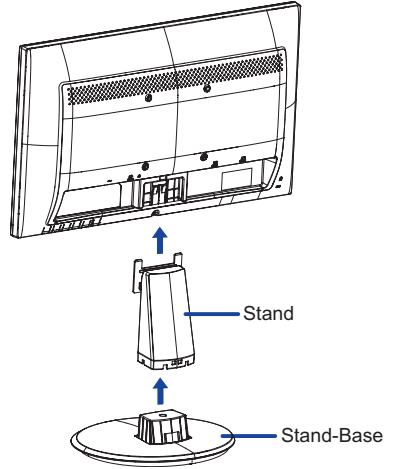

<Removal>

- ① Put a piece of soft cloth on the table beforehand to prevent the monitor from being scratched. Lay the monitor flat on a table with front face down.
- ② Keep pressing the Hooks inward to pull out the Stand-Base.
- ③ Press the stopper at the top of the stand and pull it to remove the stand from the monitor.

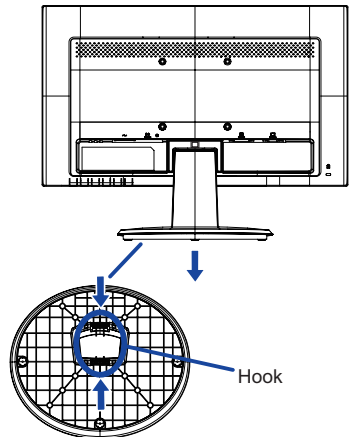
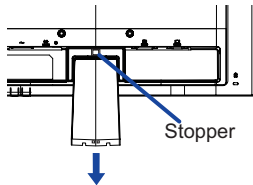

CONTROLS AND CONNECTORS : ProLite B2083HSD

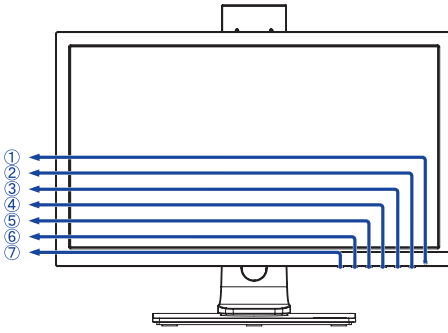

<Front>

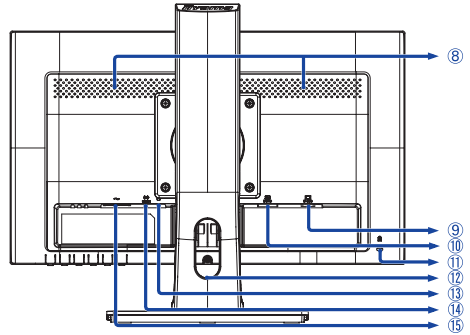

<Back>

① Power Indicator

NOTE Blue: Normal operation
Orange: Standby mode

② Power Switch ()

③ Menu / Select Button (ENTER)

④ Scroll Up / Volume Button (/)

⑤ Scroll Down / ECO Mode Button (/)

⑥ Exit Button (EXIT)

⑦ Auto Button (AUTO)

⑧ Speakers

⑨ VGA Connector (D-SUB)

⑩ DVI-D Connector (DVI-D)

⑪ Keyhole for Security Lock

NOTE You can fasten a security lock and cable to prevent the monitor from being removed without your permission.

⑫ Cable Hole

⑬ Headphone Connector ()

⑭ Audio Connector (LINE IN)

⑮ AC Connector (\sim : Alternating current) (\sim)

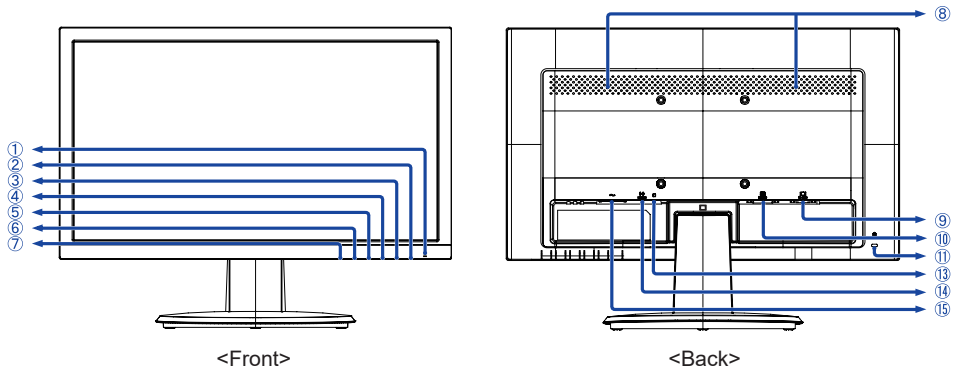

① Power Indicator

NOTE Blue: Normal operation
Orange: Standby mode

② Power Switch (⏻)

③ Menu / Select Button (ENTER)

④ Scroll Up / Volume Button (▶ / 🔊)

⑤ Scroll Down / ECO Mode Button (◀ / ⏻)

⑥ Exit Button (EXIT)

⑦ Auto Button (AUTO)

⑧ Speakers

⑨ VGA Connector (D-SUB)

⑩ DVI-D Connector (DVI-D)

⑪ Keyhole for Security Lock

NOTE You can fasten a security lock and cable to prevent the monitor from being removed without your permission.

⑬ Headphone Connector (🔊)

⑭ Audio Connector (LINE IN)

⑮ AC Connector (⚡ : Alternating current) (⚡)

CONNECTING YOUR MONITOR : ProLite B2083HS

- ① Ensure that both the computer and the monitor are switched off.
- ② Connect the computer to the monitor with the signal cable.
- ③ Connect the monitor to the audio equipment with the Audio Cable for computer when using the audio features.
- ④ Connect the Power Cable to the monitor first and then to the power source.
- ⑤ Turn on your monitor and computer.

NOTE

- Make sure that the building installation has a circuit breaker of 120/240V, 20A (maximum).
- The signal cables used for connecting the computer and monitor may vary with the type of computer used. An incorrect connection may cause serious damage to both the monitor and the computer. The cable supplied with the monitor is for a standard connector. If a special cable is required please contact your local iiyama dealer or regional iiyama office.
- Make sure you tighten the finger screws at each end of the signal cable.
- The Class I pluggable equipment Type A must be connected to protective earth.
- The socket-outlet shall be installed near the equipment and shall be easily accessible.
- Excessive sound pressure from ear-/headphones can cause hearing damage/hearing loss.

[Example of Connection]

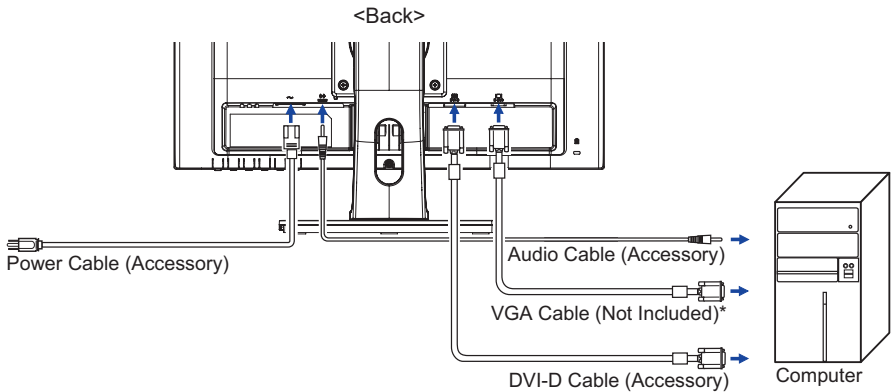

* VGA cable is not supplied with the monitor. If you use low quality VGA cable, it may cause a result of electro-magnetic interference. Please contact the iiyama Support Centre in your country if you wish to connect the monitor via the VGA input.

[Collect Cables]

Put the cables through the cable hole to bundle them.

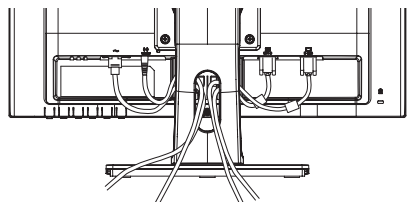

CONNECTING YOUR MONITOR : ProLite E2083HSD

- ① Ensure that both the computer and the monitor are switched off.
- ② Connect the computer to the monitor with the signal cable.
- ③ Connect the monitor to the audio equipment with the Audio Cable for computer when using the audio features.
- ④ Connect the Power Cable to the monitor first and then to the power source.
- ⑤ Turn on your monitor and computer.

NOTE

- Make sure that the building installation has a circuit breaker of 120/240V, 20A (maximum).
- The signal cables used for connecting the computer and monitor may vary with the type of computer used. An incorrect connection may cause serious damage to both the monitor and the computer. The cable supplied with the monitor is for a standard connector. If a special cable is required please contact your local iiyama dealer or regional iiyama office.
- Make sure you tighten the finger screws at each end of the signal cable.
- The Class I pluggable equipment Type A must be connected to protective earth.
- The socket-outlet shall be installed near the equipment and shall be easily accessible.
- Excessive sound pressure from ear-/headphones can cause hearing damage/hearing loss.

[Example of Connection]

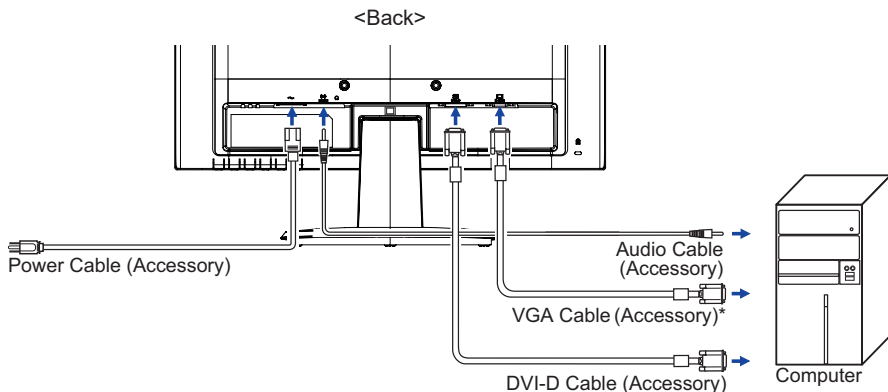

- * VGA cable is not supplied with the monitor. If you use low quality VGA cable, it may cause a result of electro-magnetic interference. Please contact the iiyama Support Centre in your country if you wish to connect the monitor via the VGA input.

COMPUTER SETTING

■ Signal Timing

Change to the desired signal timing listed on page 31: COMPLIANT TIMING.

ADJUSTING THE VIEWING ANGLE : ProLite E2083HSD

- For optimal viewing it is recommended to look at the full face of the monitor.
- Hold the stand so that the monitor does not topple when you change the monitor's angle.
- You are able to adjust the monitor's angle up to 22° upward, 5° downward.
- In order to ensure a healthy and relaxed body position when using the monitor at visual display workstations, it is recommended that the adjusted tilt angle should not exceed 10 degrees. Adjust the monitor's angle to your own preference.

NOTE

- Do not touch the LCD screen when you change the angle. It may cause damage or break the LCD screen.
- Careful attention is required not to pinch your fingers or hands into the moving part of the stand when you change the angle.

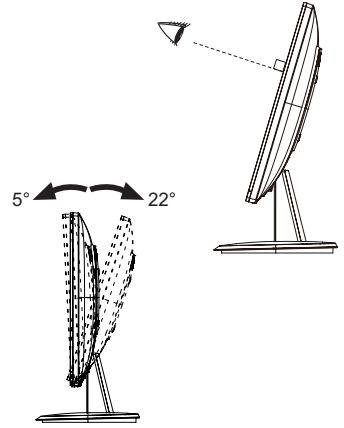

ADJUSTING THE HEIGHT AND THE VIEWING ANGLE : ProLite B2083HSD

- For optimal viewing it is recommended to position yourself directly opposite to the full face of the monitor, then adjust the monitor's height and angle to your own preference.
- Hold the panel so that the monitor does not topple when you change the monitor's height or angle.
- You are able to adjust the monitor's height up to 130mm, angle up to 45 degrees right and left, 22 degrees upward and 5 degrees downward.

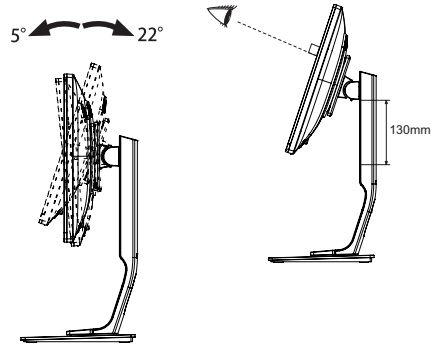

- NOTE**
- Do not touch the LCD screen when you change the height or the angle. It may cause damage or break the LCD screen.
 - Careful attention is required not to pinch your fingers or hands into the moving part of the stand when you change the height or the angle.
 - Injury can occur if care is not taken to avoid finger contact with the displays base when adjusting the height.

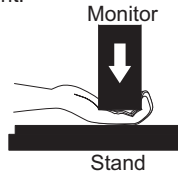
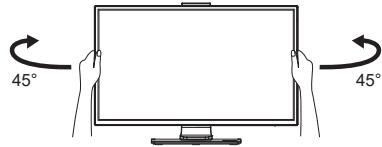

OPERATING THE MONITOR

To create the best picture, your iiyama LCD monitor has been preset at the factory with the COMPLIANT TIMING shown on page 31. You are also able to adjust the picture by following the button operation shown below. For more detailed adjustments, see page 22 for SCREEN ADJUSTMENTS.

- 1 Press the ENTER Button to start the On Screen Display feature. There are additional Menu items which can be switched by using the ◀ / ▶ Buttons.

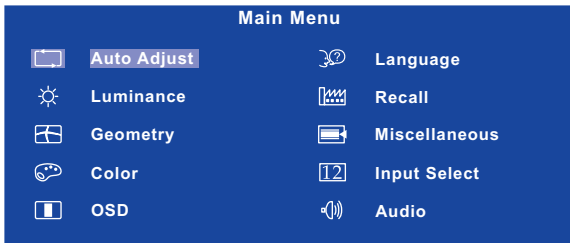

- 2 Select the Menu item which contains the adjustment icon relating to the adjustment you want to make. Press the ENTER Button. Then, use the ◀ / ▶ Buttons to highlight the desired adjustment icon.
- 3 Press the ENTER Button again. Use the ◀ / ▶ Buttons to make the appropriate adjustment or setting.
- 4 Press the EXIT Button to leave the menu, and the settings you just made would be automatically saved.

For example, to correct for vertical position, select Menu item of Geometry and then press the ENTER Button. Then, select  (V.Position) by using the ◀ / ▶ Buttons. An adjustment page appears after you press the ENTER Button.

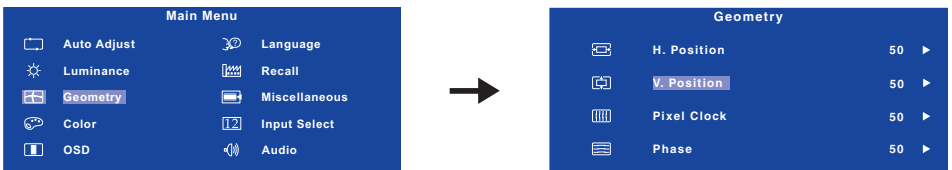

Then, use the ◀ / ▶ Buttons to change the vertical position settings. The vertical position of the overall display should be changing accordingly while you are doing this.

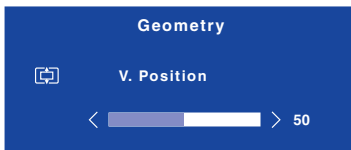

Press the EXIT Button lastly, it ends, all changes are saved in the memory.

NOTE

- When button operations are aborted during adjustment, On-Screen Display disappears when the time set for the OSD Time has passed. Also, press the EXIT button to quickly turn off the On-Screen Display.
- Any changes are automatically saved in the memory when the On Screen Display disappears. Turning off the power should be avoided while using the Menu.
- Adjustments for H. / V. Position, Pixel Clock and Phase are saved for each signal timing. Except for these adjustments, all other adjustments have only one setting which applies to all signal timings.

ADJUSTMENT MENU CONTENTS

 **Auto Adjust** Only Analog Input

Adjustment Item	Problem / Option	Button to Press
Auto Adjust * Direct	Adjust H. / V. Position, Pixel Clock and Phase automatically.	







* For best results, use the Auto Adjust in conjunction with the adjustment pattern. See page 21 for SCREEN ADJUSTMENTS.

Direct

You can skip the Menu items and directly display an adjustment scale by using the following button operations.

- Auto Adjust : Press the Auto Button when the Menu is not displayed.



























 **Luminance** *^{1,2}





Adjustment Item	Problem / Option	Button to Press
 Brightness * ³	Too dark	
	Too bright	
 Contrast	Too dull	
	Too intense	

*¹ Luminance adjustment is disabled when Adv. Contrast mode is activated.















*² Luminance adjustment is disabled when i-Style Color is activated.

*³ Adjust the Brightness when you are using the monitor in a dark room and feel the screen is too bright.



 Geometry Only Analog Input		
Adjustment Item	Problem / Option	Button to Press
 H. Position	 Too left  Too right	   
 V. Position	 Too low  Too high	   
 Pixel Clock	 Too narrow  Too wide	   
 Phase	To correct flickering text or lines	  











 Color*		
Adjustment Item	Problem / Option	Button to Press
9300K	Cool color	
7500K	Normal color	
6500K	Warm color	
User Preset	Red	   
	Green	
	Blue	Too strong

* Color adjustments is disabled when i-Style Color or Blue Light Reducer is activated.

 OSD		
Adjustment Item	Problem / Option	Button to Press
 H.Position	OSD is too left OSD is too right	   
 V.Position	OSD is too low OSD is too high	   
 OSD Time	You can set the OSD display duration time between 5 and 30 seconds.	  

 Language					
Adjustment Item		Problem / Option			Button to Press
Language	English	English	Nederlands	Dutch	
	Français	French	日本語	Japanese	
	Deutsch	German	简体中文	Simplified Chinese	
	Italiano	Italian	Русский	Russian	
	Polski	Polish	Česky	Czech	
	Español	Spanish			

 Recall			
Adjustment Item		Problem / Option	Button to Press
 Recall All	Yes	Factory-preset data is restored.	
	No	Return to Menu.	

 Miscellaneous			
Adjustment Item	Problem / Option		Button to Press
 Sharpness	1 2 3 4 5 You can change the picture quality from 1 to 5 (sharp to soft). Press the ► Button to change the picture quality in numerical order. Press the ◀ Button to change the picture quality in reverse numerical order.		 
 DDC/CI	On	DDC/CI is turned ON.	
	Off	DDC/CI is turned OFF.	
NOTE DDC/CI On and Off are switched as follows by pressing the ► Button successively. → On → Off →			
 Display Information	Displays information regarding the current input signal coming from the graphic card in your computer.		
NOTE See your graphic card user guide for more information about changing the resolution and refresh.			
 Adv. Contrast*	On	Increased Contrast Ratio	
	Off	Typical Contrast Ratio	
 Display Mode	Full	Expansion display	
	Aspect	Expansion display of Aspect	
 Opening Logo	On	iiyama Logo displayed when the monitor is turned on.	
	Off	iiyama Logo does not display when the monitor is turned on.	

* Adv. Contrast adjustments is disabled when i-Style Color is activated.

12 Input Select

Adjustment Item	Problem / Option		Button to Press
12 Input Select Direct	AUTO* ¹	D-SUB	Select the Analog input.
		DVI	Select the Digital (DVI) input.
	Manual* ²	D-SUB	Select the Analog input.
		DVI	Select the Digital (DVI) input.

NOTE *¹ It will be selected automatically when the selected signal is not available.
 *² Input source is fixed, not selected automatically when D-SUB and DVI which are selected.

Direct

You can skip the Menu items and directly display an option setting screen by using the following button operations.

- Input Select : Pressing and holding of the AUTO Button for 2-3 seconds when the Menu is not displayed.

🔊 Audio			
Adjustment Item	Problem / Option		Button to Press
🔊 Volume Direct	Too soft		👉▶
	Too loud		👉◀
🚫 Mute	On	Turn off the sound temporarily.	
	Off	Return the sound volume to the previous level.	

NOTE Mute On and Off are switched as follows by pressing the ▶ Button successively.
 ➡ On ➡ Off ◻

Direct

You can skip the Menu items and directly display an adjustment scale by using the following button operations.

- Volume : Press the ▶ Button when the Menu is not displayed.

Direct

You can skip the Menu items and directly display an option setting screen by using the following button operations.

- ECO Mode : Press the ◀ Button when the Menu is not displayed.
 - On : Brightness of back light is reduced.
 - Off : Normal
- i-Style Color * : Press the EXIT Button when the Menu is not displayed.
 - Off : Return to a state set by color adjustment.
 - Standard : For general windows environment and monitor default setting.
 - Game : For PC game environment.
 - Cinema : For movie and video environment.
 - Scenery : For displaying outdoor scenery images.
 - Text : For text editing and viewing in a word processing environment.
- * i-Style Color is disabled when Blue Light Reducer is activated.
- Blue Light Reducer * : Pressing and holding of the EXIT Button for 1-2 seconds when the Menu is not displayed.
 - Off : Normal
 - Mode1 : Blue light is reduced.
 - Mode2 : Blue light is reduced more than Mode1.
 - Mode3 : Blue light is reduced more than Mode2.
- * Blue Light Reducer is disabled when i-Style Color is activated.

■ Lock Mode

<OSD Menu>

1. The OSD lock will be activated by pressing the front button ENTER for about 10 seconds. If you try to access the OSD by pressing any of the buttons, message "OSD Locked" will appear on the screen.
2. The OSD lock will be deactivated by pressing the front button ENTER again for about 10 seconds.

<Power Switch>

1. The power switch lock will be activated by pressing the front button ◀ for about 10 seconds. Locking the power switch means that won't be able to turn off the Monitor while the power switch is locked. If presses the power switch message "Power Button Locked" will appear on the screen.
2. The power switch lock will be deactivated by pressing the front button ◀ again for about 10 seconds.

SCREEN ADJUSTMENTS

Adjust the image by following the procedure below to get the desired picture when selecting Analog input.

- The screen adjustments described in this manual are designed to set image position and minimize flicker or blur for the particular computer in use.
- The monitor is designed to provide the best performance at resolution of 1600 × 900, but can not provide the best at resolutions of less than 1600 × 900 because the picture is automatically stretched to fit the full screen. It is recommended to operate at resolution of 1600 × 900 in normal use.
- Displayed text or lines will be blurred or irregular in thickness when the picture is stretched due to the screen enlargement process.
- It is preferable to adjust the image position and frequency with the monitor controls, rather than the computer software or utilities.
- Perform adjustments after a warm-up period of at least thirty minutes.
- Additional adjustments may be required after the Auto Adjust depending on the resolution or signal timing.
- The Auto Adjust may not work correctly when displaying the picture other than the screen adjustment pattern. In this case, manual adjustments are required.

There are two ways to adjust the screen. One way is automatic adjustment for Position, Pixel Clock and Phase. The other way is performing each adjustment manually.

Perform the Auto Adjust first when the monitor is connected to a new computer, or resolution is changed. If the screen has a flicker or blur, or the picture does not fit in the display area after performing the Auto Adjust, manual adjustments are required. Both adjustments should be made by using the screen adjustment pattern (Test.bmp) obtained via the Iiyama web site (<http://www.iiyama.com>).

Adjust the image by following the procedure below to get the desired picture.

This manual explains adjustment under Windows® OS.

- ① **Display the picture at the optimum resolution.**
- ② **Enter the Test.bmp (screen adjustment pattern) to wallpaper.**

NOTE

- Consult the appropriate documentation for doing this.
- Set the display position to center in the wallpaper setting dialogue box.

[Adjustment pattern]

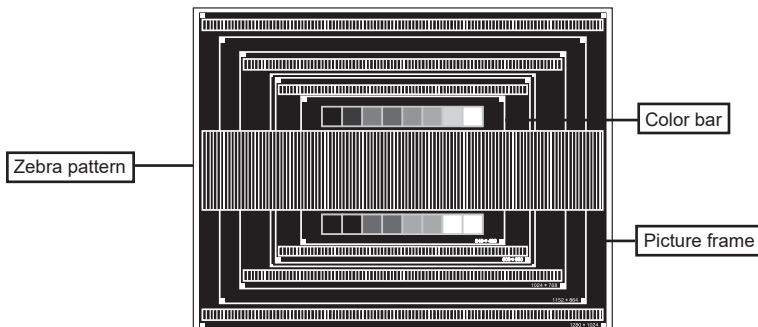

③ Press the AUTO Button. (Auto Adjust)

④ Adjust the image manually by following procedure below when the screen has a flicker or blur, or the picture does not fit in the display area after performing the Auto Adjust.

⑤ Adjust the V.Position so that the top and bottom of the picture frame will fit to the display area.

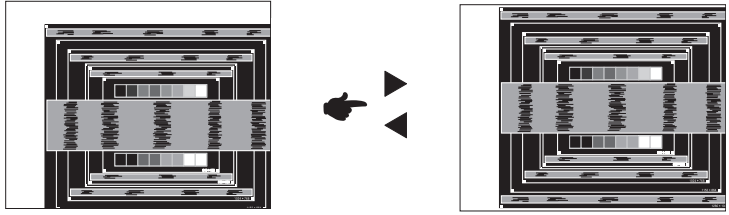

⑥ 1) Adjust the H.Position so that the left side of the picture frame will move to the left edge of the display area.

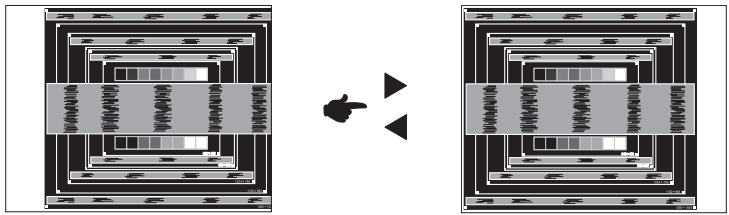

2) Stretch the right side of the picture frame to the right edge of the display area by adjusting the Pixel Clock.

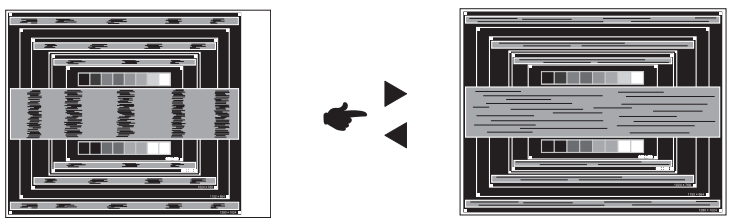

- NOTE**
- When the left side of the picture frame moves apart from the left edge of the display area during the Pixel Clock adjustment, adjust steps 1) and 2).
 - Another way to make the Pixel Clock adjustment is to correct the vertical wavy lines in the zebra pattern.
 - The picture may flicker during the Pixel Clock, H.Position and V.Position adjustment.
 - In case the picture frame is bigger or smaller than the data display area after the Pixel Clock adjustment, repeat steps from ③.

- ⑦ **Adjust the Phase to correct horizontal wavy noise, flicker or blur in the zebra pattern.**

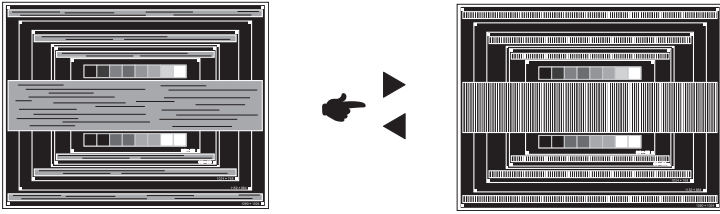

NOTE

- In case the strong flicker or blurs remain on a part of the screen, repeat steps ⑥ and ⑦ because the Pixel Clock may not be adjusted correctly.
- Adjust the H.Position after the Phase adjustment if the horizontal position moves during the adjustment.

- ⑧ **Adjust the Brightness and Color to get the desired picture after you complete the Pixel Clock and Phase adjustments.**

Put back your favorite wallpaper.

STANDBY FEATURE

The standby feature of this product complies with power saving requirement of VESA DPMS. When activated, it automatically reduces unnecessary power consumption of the monitor when your computer is not in use.

To use the feature, the monitor needs to be connected to a VESA DPMS compliant computer. There is a standby step the monitor takes as described below. The standby function, including any timer settings is configured by the operating system. Check your operating system manual for information on how this can be configured.

■ Standby Mode

When the video signal from the computer is off, the monitor enters into Standby Mode which reduces the power consumption to less than 0.5W*. The screen becomes dark, and the power indicator turns to orange. From Standby Mode, the image reappears in several seconds when either the keyboard or the mouse are touched again.

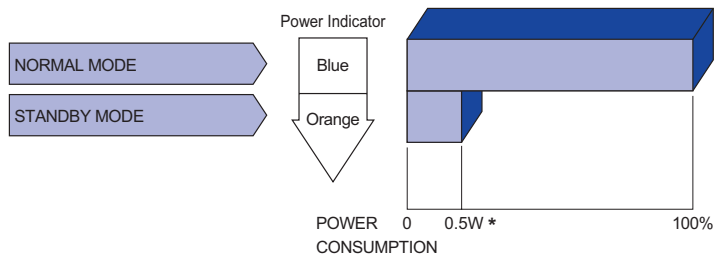

* Audio equipment is not connected.

NOTE

Even when using the standby mode, the monitor consumes electricity. Turn off the Power Switch whenever the monitor is not in use, during the night and weekends, to avoid unnecessary power consumption.

TROUBLE SHOOTING

If the monitor fails to operate correctly, please follow the steps below for a possible solution.

1. Perform the adjustments described in OPERATING THE MONITOR, depending on the problem you have. If the monitor does not get a picture, skip to 2.
2. Consult the following items if you cannot find an appropriate adjustment item in OPERATING THE MONITOR or if the problem persists.
3. If you are experiencing a problem which is not described below or you cannot correct the problem, discontinue using the monitor and contact your dealer or iiyama service center for further assistance.

Problem

Check

- ① The picture does not appear.

(Power indicator does not light up.)

- The Power Cable is firmly seated in the socket.
- The Power Switch is turned ON.
- The AC socket is live. Please check with another piece of equipment.

(Power indicator is blue.)

- If the blank screen saver is in active mode, touch the keyboard or the mouse.
- Increase the Contrast and/or Brightness.
- The computer is ON.
- The Signal Cable is properly connected.
- The signal timing of the computer is within the specification of the monitor.

(Power indicator is orange.)

- If the monitor is in standby mode, touch the keyboard or the mouse.
- The computer is ON.
- The Signal Cable is properly connected.
- The signal timing of the computer is within the specification of the monitor.

- ② The screen is not synchronized.

- The Signal Cable is properly connected.
- The signal timing of the computer is within the specification of the monitor.

- ③ The screen position is not in the center.

- The signal timing of the computer is within the specification of the monitor.

- ④ The screen is too bright or too dark.

- The video output level of the computer is within the specification of the monitor.

Problem

Check

- | | |
|---------------------------------------|--|
| ⑤ The screen is shaking. | <input type="checkbox"/> The power voltage is within the specification of the monitor.
<input type="checkbox"/> The signal timing of the computer is within the specification of the monitor. |
| ⑥ No sound. | <input type="checkbox"/> The audio equipment (computer etc.) is ON.
<input type="checkbox"/> The Audio Cable is properly connected.
<input type="checkbox"/> The Volume is turned up.
<input type="checkbox"/> The Mute is OFF.
<input type="checkbox"/> The audio output level of the audio equipment is within the specification of the monitor. |
| ⑦ The sound is too loud or too quiet. | <input type="checkbox"/> The audio output level of the audio equipment is within the specification of the monitor. |
| ⑧ A strange noise is heard. | <input type="checkbox"/> The Audio Cable is properly connected. |

RECYCLING INFORMATION

For better environment protection please don't dispose your monitor.
Please visit our web site: www.iiyama.com for monitor recycling.

APPENDIX

Design and specifications are subject to change without prior notice.

SPECIFICATIONS : ProLite B2083HSD

ENGLISH

Size Category	20"	
LCD Panel	Panel technology	TN
	Size	Diagonal: 19.5" (49.4cm)
	Pixel pitch	0.271mm H × 0.271mm V
	Brightness	250cd/m ² (Typical)
	Contrast ratio	1000 : 1 (Typical), Adv. Contrast Function Available
	Viewable angle	Right / Left : 85 degrees each, Up / Down : 80 degrees each (Typical)
	Response time	5ms (Typical)
Display Colors	Approx. 16.7M	
Sync Frequency	Horizontal: 30.0-80.0kHz, Vertical: 55-75Hz	
Native Resolution	1600 × 900, 1.4 MegaPixels	
Support max. resolution	VGA: 1600 × 900 60Hz DVI: 1600 × 900 60Hz	
Input Connector	VGA, DVI-D	
Plug & Play	VESA DDC2B™	
Input Sync Signal	Separate sync: TTL, Positive or Negative	
Input Video Signal	Analog: 0.7Vp-p (Standard), 75Ω, Positive Digital: DVI (Digital Visual Interface Standard Rev.1.0) compliance	
Input Audio Connector	ø 3.5mm mini jack (Stereo)	
Input Audio Signal	1.0Vrms maximum	
Speakers	1W × 2 (Stereo speakers)	
Maximum Screen Size	433.9mm W × 236.3mm H / 17.1" W × 9.3" H	
Power Source	100-240VAC, 50/60Hz, 1.0A	
Power Consumption*	15W typical, Standby mode: 0.5W maximum	
Dimensions / Net Weight	469.5 × 348.0 - 478.0 × 210.0mm / 18.5 × 13.7 - 18.8 × 8.3" (W×H×D) 4.3kg / 9.48lbs	
Angle	Tilt: Upward: 22 degrees Downward: 5 degrees Swivel: Left / Right: 45 degrees each Rotation: Clockwise: 90 degrees	
Environmental Considerations	Operating:	Temperature 5 to 35°C / 41 to 95°F Humidity 10 to 80% (No condensation)
	Storage:	Temperature -20 to 60°C / -4 to 140°F Humidity 5 to 85% (No condensation)
Approvals	CE, TÜV-GS, VCCI, EAC	

NOTE * Audio equipment is not connected.

SPECIFICATIONS : ProLite E2083HSD

Size Category	20"	
LCD Panel	Panel technology	TN
	Size	Diagonal: 19.5" (49.4cm)
	Pixel pitch	0.271mm H × 0.271mm V
	Brightness	250cd/m ² (Typical)
	Contrast ratio	1000 : 1 (Typical), Adv. Contrast Function Available
	Viewable angle	Right / Left : 85 degrees each, Up / Down : 80 degrees each (Typical)
	Response time	5ms (Typical)
Display Colors	Approx. 16.7M	
Sync Frequency	Horizontal: 30.0-80.0kHz, Vertical: 55-75Hz	
Native Resolution	1600 × 900, 1.4 MegaPixels	
Support max. resolution	VGA: 1600 × 900 60Hz DVI: 1600 × 900 60Hz	
Input Connector	VGA, DVI-D	
Plug & Play	VESA DDC2B™	
Input Sync Signal	Separate sync: TTL, Positive or Negative	
Input Video Signal	Analog: 0.7Vp-p (Standard), 75Ω, Positive Digital: DVI (Digital Visual Interface Standard Rev.1.0) compliance	
Input Audio Connector	ø 3.5mm mini jack (Stereo)	
Input Audio Signal	1.0Vrms maximum	
Speakers	1W × 2 (Stereo speakers)	
Maximum Screen Size	433.9mm W × 236.3mm H / 17.1" W × 9.3" H	
Power Source	100-240VAC, 50/60Hz, 1.0A	
Power Consumption*	15W typical, Standby mode: 0.5W maximum	
Dimensions / Net Weight	469.5 × 360.0 × 203.0mm / 18.5 × 14.2 × 8.0" (W×H×D) 2.7kg / 5.95lbs	
Tilt Angle	Upward: 22 degrees Downward: 5 degrees	
Environmental Considerations	Operating:	Temperature 5 to 35°C / 41 to 95°F Humidity 10 to 80% (No condensation)
	Storage:	Temperature -20 to 60°C / -4 to 140°F Humidity 5 to 85% (No condensation)
Approvals	CE, TÜV-GS, VCCI, EAC	

NOTE * Audio equipment is not connected.

DIMENSIONS : ProLite B2083HSD

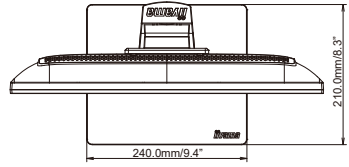
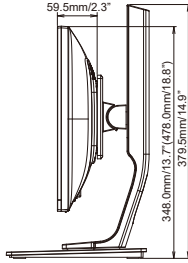
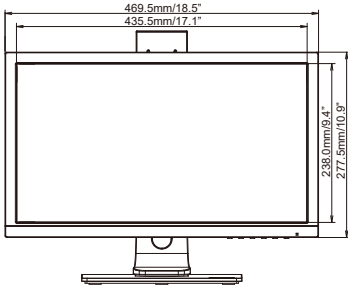

() : Maximum adjustment range

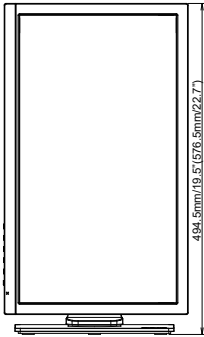

DIMENSIONS : ProLite E2083HSD

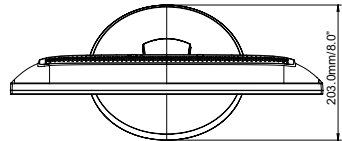
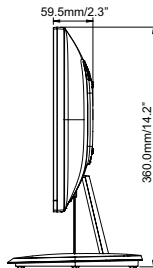
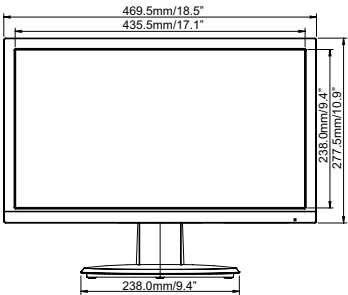

COMPLIANT TIMING

Video Mode	Horizontal Frequency	Vertical Frequency	Dot Clock
640 × 480	31.469kHz	59.940Hz	25.175MHz
	37.500kHz	75.000Hz	31.500MHz
800 × 600	37.879kHz	60.317Hz	40.000MHz
	46.875kHz	75.000Hz	49.500MHz
1024 × 768	48.363kHz	60.004Hz	65.000MHz
	60.023kHz	75.029Hz	78.750MHz
1280 × 1024	63.981kHz	60.020Hz	108.000MHz
	79.976kHz	75.025Hz	135.000MHz
1600 × 900	55.540kHz	60.000Hz	97.750MHz
640 × 350	31.469kHz	70.087Hz	25.175MHz
720 × 400	31.469kHz	70.087Hz	28.322MHz

NOTE * DVI input is not compliant.