

Mounting Instructions

Fixed Universal Screen Bracket
052.1000 / 052.2000 / 052.6000

1 Mounting screen profiles

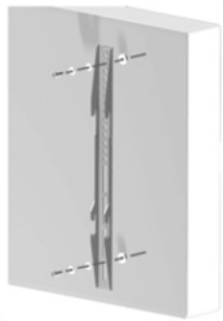

Mount the screen profiles to the back of the screen. Divide the profiles as well as possible.

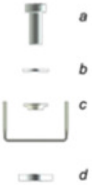

* use M4, M5, M6 or M8 mounting material (depending on flat screen) (spacers only if necessary)

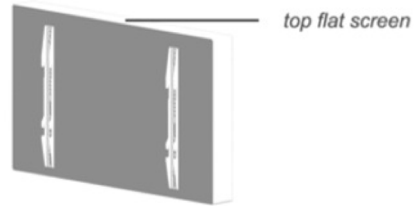

2x

2 Ensure there is a minimum distance of least at least 1.5 m between the wall and one side of the mounting plate, to install the locking bar at step 4. Mounting back plate

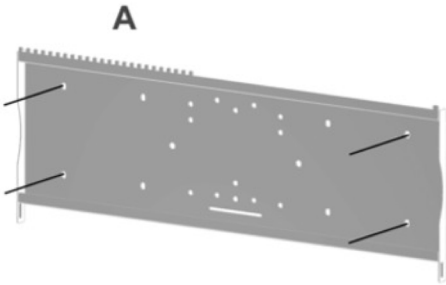

Mounting back plate to the wall

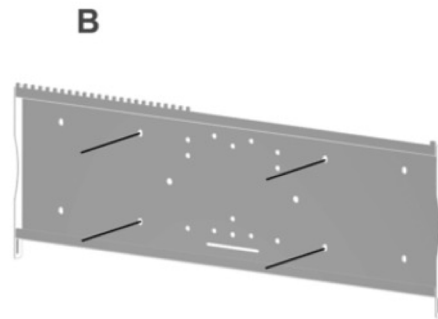

Mounting back plate to the wall (alternative mounting positions)

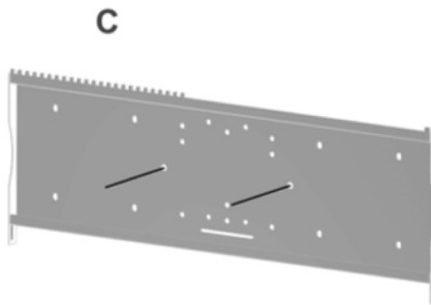

Mounting back plate to truss

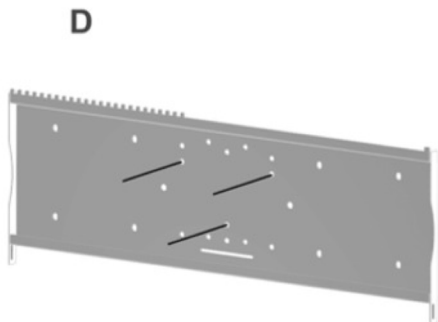

Mounting back plate to flat screen stand

Mounting Instructions

Fixed Universal Screen Bracket
052.1000 / 052.2000 / 052.6000

3 Connecting flat screen to base plate

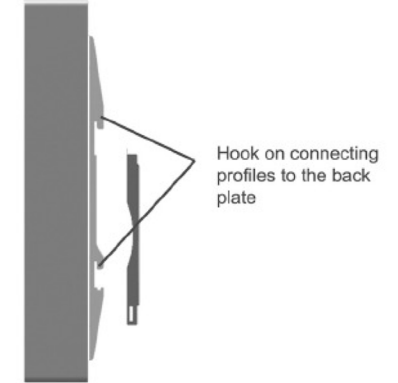
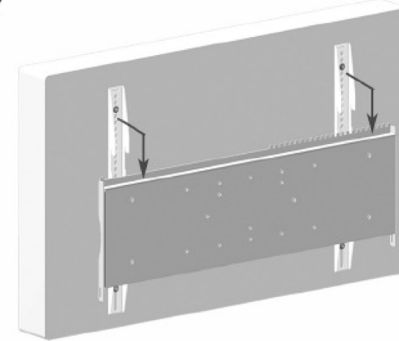

Hook on connecting profiles to the back plate

4 Transit locking bar

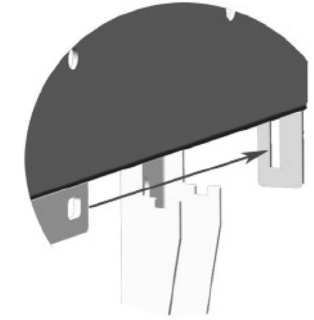
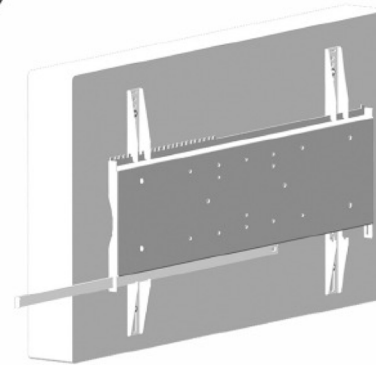

Transit the locking bar through the 'cheeks' of the back plate.

5 Lock (optional)

