

USER MANUAL

ProLite

LCD Monitor

ENGLISH

ProLite LH3254HS
ProLite LH4354UHS
ProLite LH5054UHS
ProLite LH5554UHS
ProLite LH6554UHS
ProLite LH7554UHS
ProLite LH8654UHS

Thank you very much for choosing the iiyama LCD monitor for signage. We recommend that you take a few minutes to read this comprehensive manual carefully before installing and switching on the monitor. Please keep this manual in a safe place for your future reference.



Dear user, we congratulate you on the purchase of your iiyama LCD.

For details on warranty and locally used pixel policies that apply directly after installation of your product please check the iiyama website.

To report a fault, please contact your local support centre found at <https://iiyama.com>

Things to check before you call the iiyama information line

- | if the power cable is connected securely and turned on?
- | if the display has been turned on?
- | if the signal cable is connected securely and the correct input selected?
- | if the computer has been restarted with the display connected?
- | if the graphics card is correctly installed with the latest drivers possible?
- | if the correct native resolution has been selected via 'Display Properties'?
- | If the R/G/B signal configuration is correct?
- | if the displays On Screen Menu is shown?
- | if the correct brightness and contrast settings have been set?
- | if given display tolerances and compatibility have been considered?
- | if via the On Screen Menu you have performed a Factory Reset/Recall?

Before reporting the screen defect, please prepare the following information/evidence:

- | model number *
- | purchase receipt and serial number *
- | name and address for collection
- | telephone/fax number, for availability during the day
- | convenient collection date (date, time)
- | short description of the defect

Important Note:

If there is no fault found in the collected equipment after inspection, the transferring party shall incur charges for transport and administration.

If you have checked all of the above and there is still no picture, call our information line for assistance in your country.

* see the identification plate on the back of the case.

CE MARKING DECLARATION OF CONFORMITY

This LCD monitor complies with the requirements of the EC/EU Directive 2014/53/EU "RED Directive", 2009/125/EC "ErP Directive" and 2011/65/EU "RoHS Directive".

Warning

This equipment is compliant with Class A of EN55032. In a residential environment this equipment may cause radio interference.

Radiation Exposure Statement:

This equipment complies with CE radiation exposure limits set forth for an uncontrolled environment. This equipment should be installed and operated with minimum distance 20cm between the radiator & body.

Operating Frequency range and the maximum output power (EIRP) are listed below:
PL3254 & PL4354U & PL5054U

Function	Frequency	Maximum Output Power (EIRP)
WiFi	2412-2472 MHz	19.19 dBm
	5180-5240 MHz	20.75 dBm
	5260-5320 MHz	20.75 dBm
	5500-5700 MHz	20.67 dBm
	5745-5825 MHz	11.64 dBm
Bluetooth	2402-2480 MHz	15.28 dBm

PL5554U & PL6554U & PL7554U & PL8654U

Function	Frequency	Maximum Output Power (EIRP)
WiFi	2412-2472 MHz	19.19 dBm
	5180-5240 MHz	20.75 dBm
	5260-5320 MHz	20.75 dBm
	5500-5700 MHz	20.66 dBm
	5745-5825 MHz	11.64 dBm
Bluetooth	2402-2480 MHz	15.28 dBm

IYYAMA CORPORATION: Wijkmeerstraat 8, 2131 HA Hoofddorp, The Netherlands

Model No. : PL3254, PL4354U, PL5054U, PL5554U, PL6554U, PL7554U, PL8654U



We recommend recycling of used product. Please contact your dealer or iiyama service center. Recycle information is obtained via the Internet, using the address: <https://iiyama.com>

You can access the Web page of different countries from there.

- We reserve the right to change specifications without notice.
- All trademarks used in this user manual are the property of their respective owners.
- Eprel registration number LH3254HS-B1AG : 1403417, LH4354UHS-B1AG : 1406531, LH5054UHS-B1AG : 1572057, LH5554UHS-B1AG : 1407255, LH6554UHS-B1AG : 1408346, LH7554UHS-B1AG : 1408404, LH8654UHS-B1AG : 1520414

TABLE OF CONTENTS

FOR YOUR SAFETY.....	1
SAFETY PRECAUTIONS.....	1
SPECIAL NOTES ON LCD MONITORS	3
CUSTOMER SERVICE	5
CLEANING	5
BEFORE YOU OPERATE THE MONITOR	6
FEATURES.....	6
CHECKING THE CONTENTS OF THE PACKAGE	7
UNPACKING	7
CONTROLS AND CONNECTORS : MONITOR.....	8
INSTALLATION	12
FUNCTIONS OF THE REMOTE CONTROL	15
PREPARING THE REMOTE CONTROL.....	16
ID REMOTE CONTROL.....	17
BASIC OPERATION.....	18
CONNECTING YOUR MONITOR : ProLite LH3254HS	21
CONNECTING YOUR MONITOR : ProLite LH4354UHS / ProLite LH5054UHS / ProLite LH5554UHS / ProLite LH6554UHS ..	22
CONNECTING YOUR MONITOR : ProLite LH7554UHS / ProLite LH8654UHS	23
COMPUTER SETTING	26
OPERATING THE MONITOR.....	27
ADJUSTMENT MENU CONTENTS	29
SCREEN ADJUSTMENTS	51
STANDBY FEATURE	54
TROUBLE SHOOTING	55
RECYCLING INFORMATION.....	56
APPENDIX	57
SPECIFICATIONS : ProLite LH3254HS-B1AG	57
SPECIFICATIONS : ProLite LH4354UHS-B1AG	58
SPECIFICATIONS : ProLite LH5054UHS-B1AG	59
SPECIFICATIONS : ProLite LH5554UHS-B1AG	60
SPECIFICATIONS : ProLite LH6554UHS-B1AG	61
SPECIFICATIONS : ProLite LH7554UHS-B1AG	62
SPECIFICATIONS : ProLite LH8654UHS-B1AG	63
DIMENSIONS : ProLite LH3254HS.....	64
DIMENSIONS : ProLite LH4354UHS	64
DIMENSIONS : ProLite LH5054UHS	65
DIMENSIONS : ProLite LH5554UHS	65
DIMENSIONS : ProLite LH6554UHS	66
DIMENSIONS : ProLite LH7554UHS	66
DIMENSIONS : ProLite LH8654UHS	67
COMPLIANT TIMING.....	67

FOR YOUR SAFETY

SAFETY PRECAUTIONS

WARNING

STOP OPERATING THE MONITOR WHEN YOU SENSE TROUBLE

If you notice any abnormal phenomena such as smoke, strange sounds or fumes, unplug the monitor and contact your dealer or iiyama service center immediately. Further use may be dangerous and can cause fire or electric shock.

NEVER REMOVE THE CABINET

High voltage circuits are inside the monitor. Removing the cabinet may expose you to the danger of fire or electric shock.

DO NOT PUT ANY OBJECT INTO THE MONITOR

Do not put any solid objects or liquids such as water into the monitor. In case of an accident, unplug your monitor immediately and contact your dealer or iiyama service center. Using the monitor with any object inside may cause fire, electric shock or damage.

INSTALL THE MONITOR ON A FLAT, STABLE SURFACE

The monitor may cause an injury if it falls or is dropped.

DO NOT USE THE MONITOR NEAR WATER

Do not use where water may be splashed or spilt onto the monitor as it may cause fire or electric shock.

OPERATE UNDER THE SPECIFIED POWER SUPPLY

Be sure to operate the monitor only with the specified power supply. Use of an incorrect voltage will cause malfunction and may cause fire or electric shock.

PROTECT THE CABLES

Do not pull or bend the power cable and signal cable. Do not place the monitor or any other heavy objects on the cables. If damaged, the cables may cause fire or electric shock.

ADVERSE WEATHER CONDITIONS

It is advisable not to operate the monitor during a heavy thunder storm as the continual breaks in power may cause malfunction. It is also advised not to touch the plug in these circumstances as it may cause electric shock.

CAUTION

INSTALLATION LOCATION

Do not install the monitor where sudden temperature changes may occur, or in humid, dusty or smoky areas as it may cause fire, electric shock or damage. You should also avoid areas where the sun shines directly on the monitor.

DO NOT PLACE THE MONITOR IN A HAZARDOUS POSITION

The monitor may topple and cause injury if not suitably located. Please also ensure that you do not place any heavy objects on the monitor, and that all cables are routed such that children may not pull the cables and possibly cause injury.

MAINTAIN GOOD VENTILATION

Ventilation slots are provided to keep the monitor from overheating. Covering the slots may cause fire. To allow adequate air circulation, place the monitor at least 10 cm (or 4 inches) from any walls. Operating the monitor on its back, side, upside down or on a carpet or any other soft material may also cause damage.

DISCONNECT THE CABLES WHEN YOU MOVE THE MONITOR

When you move the monitor, turn off the power switch, unplug the monitor and be sure the signal cable is disconnected. If you do not disconnect them, it may cause fire or electric shock.

UNPLUG THE MONITOR

If the monitor is not in use for a long period of time it is recommended that it is left unplugged to avoid accidents.

HOLD THE PLUG WHEN DISCONNECTING

To disconnect the power cable or signal cable, always pull it by the plug. Never pull on the cable itself as this may cause fire or electric shock.

DO NOT TOUCH THE PLUG WITH WET HANDS

Pulling or inserting the plug with wet hands may cause electric shock.

WHEN YOU INSTALL THE MONITOR ON YOUR COMPUTER

Be sure the computer is strong enough to hold the weight of the monitor, otherwise, you may damage your computer.

OTHERS

ERGONOMIC RECOMMENDATIONS

To eliminate eye fatigue, do not operate the monitor against a bright background or in a dark room. For optimal viewing comfort, the monitor should be just below eye level and 40-60 cm (16-24 inches) away from your eyes. When using the monitor over a prolonged time, a ten minute break every hour is recommended as looking at the screen continuously can cause eye strain.

SPECIAL NOTES ON LCD MONITORS

- The following symptoms are normal with LCD monitors and do not indicate a problem.

NOTE

- When you first turn on the LCD monitor, the picture may not fit in the display area because of the type of computer that is used. In this case, adjust the picture position to the correct position.
 - You may find slightly uneven brightness on the screen depending on the desktop pattern you use.
 - Due to the nature of the LCD screen, an afterimage of the previous screen may remain after switching the image, when the same image is displayed for hours. In this case, the screen is recovered slowly by changing the image or turning off the Power Switch for hours.
- This LCD cannot be used outdoors.
 - This LCD cannot be used with the screen facing upwards.
 - If you use a cable longer than the supplied one, the picture quality is not guaranteed.

USAGE CONFIRMATION

Product maximum non-stop usage hours following the installation guidelines in a clean and temperature-controlled environment: 24/7

The monitor is compatible for usage in Landscape/Portrait applications.

IMAGE PERSISTENCE / IMAGE STICKING

Please be aware that all LCD screens can experience Image Persistence or Image Sticking. This occurs when a residual image remains visible on a screen when static images are displayed for long periods of time. LCD Image Persistence is not permanent but constant images being displayed for a long period of time should be avoided.

To counteract Image Persistence, turn off the monitor for as long as the previous image was displayed, so if an image was on the monitor for 1 hour and there is evidence of a residual or "ghost" image, you should turn off the monitor for 1 hour in order to clear the residual image.

For all LFD products, iiyama recommends displaying moving images and utilising a moving screen saver at regular intervals whenever the screen is idle. You could also turn off the monitor when not in use to assist the prevention.

Other ways to reduce the risk of Image Persistence will be to utilise the FAN-on function (if available), Low Backlight and Low Brightness settings.

FOR EXTENDED USE AS A PUBLIC MONITOR

■ Image Sticking on LCD Panel

When a static image is displayed for hours, an electric charge trace remains near the electrode inside the LCD producing a "ghost" image. (Image Persistence).

Image Persistence is not a permanent feature.

■ Recommendations

To prevent Image Sticking and promote longer life expectancy of monitor, we recommend the following:

1. Avoid static images displayed for long periods – change static images on continuous loop.
2. Turn off monitor when not in use, either by remote control or use Standby or Schedule functions.
3. Check the Monitor Menu Settings for "Pixel Shift" etc. and activate it when available. This will reduce the Image Sticking Effect.
4. When monitor is installed in high ambient temperature environment(s) or in an enclosed position, utilise the Cooling Fan, Screen Saver and Low Brightness functions.
5. Suitable ventilation for any monitor is an expectation of any installation – climate control systems may need to be employed.
6. We strongly recommend utilisation of active cooling with fans for long operation times or high ambient temperature environments.

CUSTOMER SERVICE

NOTE

- If you have to return your unit for service and the original packaging has been discarded, please contact your dealer or iiyama service center for advice or replacement packaging.

CLEANING

WARNING

- If you drop any materials or liquids such as water into the monitor when cleaning, unplug the power cable immediately and contact your dealer or iiyama service center.

CAUTION

- For safety reasons, turn off the power switch and unplug the monitor before you clean it.

NOTE

- To protect the LCD panel, do not scratch or rub the screen with a hard object.
- Never use any of the following strong solvents. These will damage the cabinet and the LCD screen.

Thinner	Benzine	Abrasive cleaner
Spray-type cleaner	Wax	Acid or Alkaline solvent

- Touching the cabinet with any product made from rubber or plastic for a long time may cause degeneration or loss of paint on the cabinet.

CABINET

Stains can be removed with a cloth lightly moistened with a mild detergent solvent. Then wipe the cabinet with a soft dry cloth.

LCD

Periodic cleaning with a soft dry cloth is recommended.

SCREEN

Don't use tissue paper etc. because these will damage the LCD screen.

BEFORE YOU OPERATE THE MONITOR

FEATURES

- ◆ Supports Resolutions up to 1920 × 1080 : ProLite LH3254HS
- ◆ Supports Resolutions up to 3840 × 2160 : ProLite LH4354UHS / ProLite LH5054UHS / ProLite LH5554UHS / ProLite LH6554UHS / ProLite LH7554UHS / ProLite LH8654UHS
- ◆ High Contrast 1200:1 (Typical) / Brightness 500cd/m² (Typical) : ProLite LH3254HS / ProLite LH4354UHS / ProLite LH5554UHS / ProLite LH6554UHS / ProLite LH7554UHS
- ◆ High Contrast 5000:1 (Typical) / Brightness 500cd/m² (Typical) : ProLite LH5054UHS
- ◆ High Contrast 1400:1 (Typical) / Brightness 500cd/m² (Typical) : ProLite LH8654UHS
- ◆ Digital Character Smoothing
- ◆ Automatic Set-up
- ◆ Stereo Speakers
2 × 10W Stereo Speakers
- ◆ Standby Feature
- ◆ VESA Mounting Standard (200mm×200mm) Compliant : ProLite LH3254HS / ProLite LH4354UHS
- ◆ VESA Mounting Standard (400mm×400mm) Compliant : ProLite LH5054UHS / ProLite LH5554UHS / ProLite LH6554UHS
- ◆ VESA Mounting Standard (600mm×400mm) Compliant : ProLite LH7554UHS / ProLite LH8654UHS

CHECKING THE CONTENTS OF THE PACKAGE

The following accessories are included in your package. Check to see if they are enclosed with the monitor. If anything is missing or damaged, please contact your local iiyama dealer or regional iiyama office.

- Power Cable*
- Remote Control
- Stickers for screw holes
1 sheet (Stickers: 10pcs : ProLite LH3254HS / ProLite LH4354UHS / ProLite LH5054UHS / ProLite LH5554UHS / ProLite LH7554UHS
Stickers: 20pcs : ProLite LH6554UHS / ProLite LH8654UHS)
- EU Energy Label
- HDMI Cable
- Battery (2pcs)
- RS-232C Cable
- Safety Guide
- Quick Start Guide

CAUTION

- * The rating of the Power Cable enclosed in 120V area is 10A/125V. If you are using a power supply higher than this rating, then a power cable with a rating of 10A/250V must be used. However, all guarantees and warranties are void for any problems or damage caused by a power cable not supplied by iiyama.
An approved power cable greater or equal to H05VVf, 3G, 0.75mm² must be used.

UNPACKING

CAUTION

Moving the monitor requires at least two people. If not, it may drop and could result in a serious injury.

CONTROLS AND CONNECTORS : MONITOR

<Back Controller>

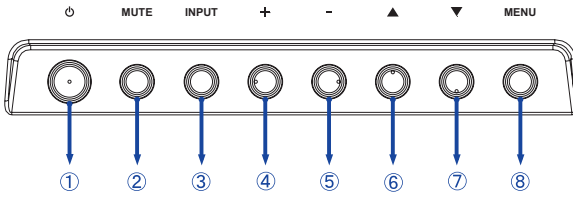

①		Power Button
②	MUTE	Mute Button
③	INPUT	Input Select Button
④	+	+ Button
⑤	-	- Button
⑥	▲	Up Button
⑦	▼	Down Button
⑧	MENU	Menu Button

<Front>

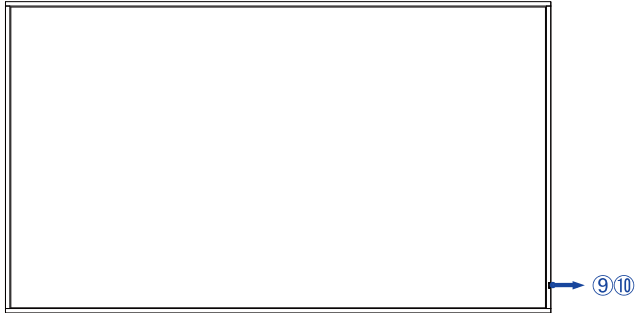

⑨	Power Indicator	Green	Lighting : Normal Operation Flash : When SCHEDULE is enabled.
		Orange	Signal Standby Mode
		Red	Power Off
⑩	Remote Sensor		Remote Sensor

<Back>

■ ProLite LH3254HS

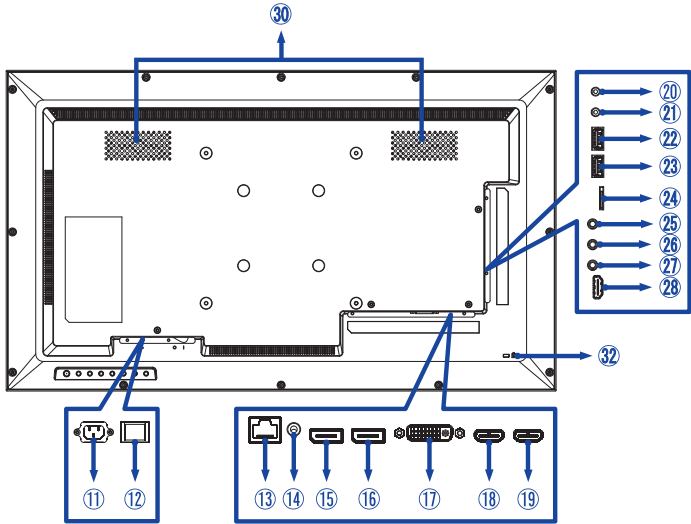

■ ProLite LH4354UHS / ProLite LH5054UHS

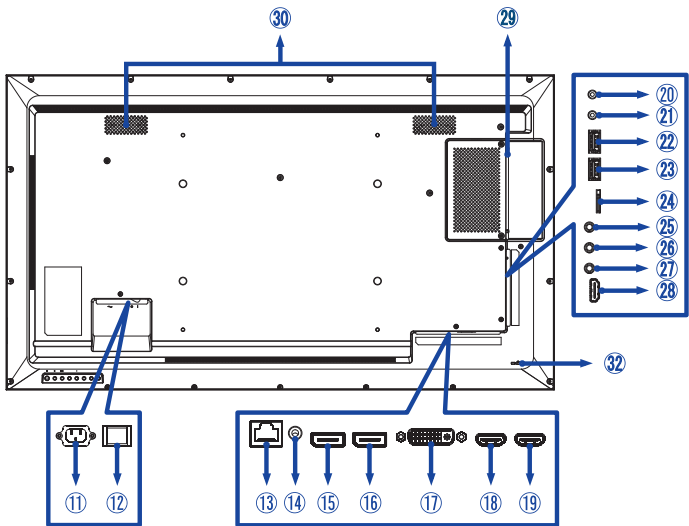

■ ProLite LH5554UHS / ProLite LH6554UHS

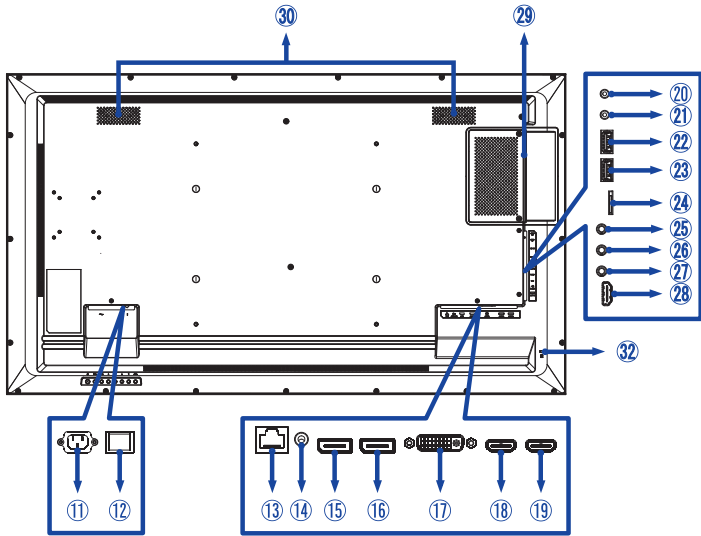

■ ProLite LH7554UHS / ProLite LH8654UHS

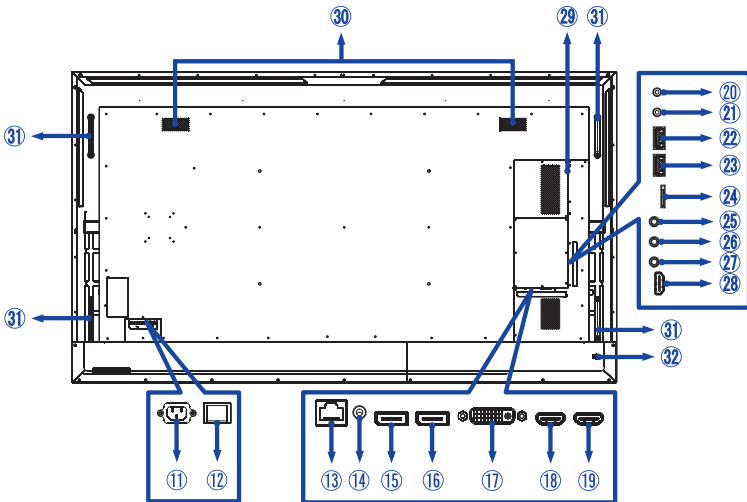

⑪	AC IN	AC-INLET	AC Connector(~ : Alternating current) (~) (AC-IN)
⑫	AC SWITCH I (ON) / O (OFF)	MAIN POWER	Main Power Switch
⑬	LAN	RJ45	RJ45 Connector
⑭	AUDIO OUT	ø 3.5mm Mini Jack	Headphone Connector
⑮	DisplayPort IN	DisplayPort	DisplayPort Connector
⑯	DisplayPort OUT	DisplayPort	DisplayPort Connector
⑰	DVI IN	DVI-I	DVI-I Connector
⑱	HDMI1 IN	HDMI	HDMI Connector
⑲	HDMI2 IN	HDMI	HDMI Connector
⑳	RS232C OUT	ø 2.5mm Sub-mini Jack	RS232C Connector
㉑	RS232C IN	ø 2.5mm Sub-mini Jack	RS232C Connector
㉒	USB2	USB2.0 (5V, 500mA)	USB Connector
㉓	USB1	USB2.0 (5V, 500mA)	USB Connector
㉔	MICRO SD		Micro SD slot
㉕	IR OUT	ø 3.5mm Mini Jack	IR Connector
㉖	IR IN	ø 3.5mm Mini Jack	IR Connector
㉗	AUDIO IN	ø 3.5mm Mini Jack	Audio Connector
㉘	HDMI3 IN	HDMI (HDMI ARC support)*	HDMI Connector
㉙	Option Slot (SDM-S: ProLite LH4354UHS, SDM-L: ProLite LH5054UHS / ProLite LH5554UHS / ProLite LH6554UHS / ProLite LH7554UHS / ProLite LH8654UHS)		
㉚	Speakers		
㉛	Handles		
㉜	Keyhole for Security Lock		

* The HDMI ARC function is only available when you enable HDMI with One Wire.
The connected device (e.g. soundbar) needs to have/support HDMI ARC.

INSTALLATION

CAUTION

- Follow the manual instructions for the type of mount you have selected. Refer all servicing to qualified service personnel.
- Moving the monitor requires at least two people.
- Before installing, please make sure the wall is strong enough to hold the necessary weight of the monitor and the mount.

[WALL MOUNTING]

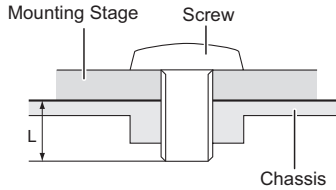

CAUTION

When using the wall mounting, consideration of thickness of the mounting stage needs to be taken. Tighten the M4/M6/M8* Screws (4pcs) which "L" length is 8/10/15/16/30mm* to fasten the monitor. Using a screw longer than this may cause electric shock or damage because it may contact with the electrical parts inside the monitor.

- * M4(L=8mm) : ProLite LH3254HS
- M6(L=10mm) : ProLite LH4354UHS / ProLite LH5054UHS / ProLite LH5554UHS
- M8(L=16mm) : ProLite LH6554UHS
- M8(L=15mm) : ProLite LH7554UHS
- M8(L=30mm) : ProLite LH8654UHS

[ROTATING THE MONITOR]

This monitor is designed to be compatible in both landscape and portrait modes.

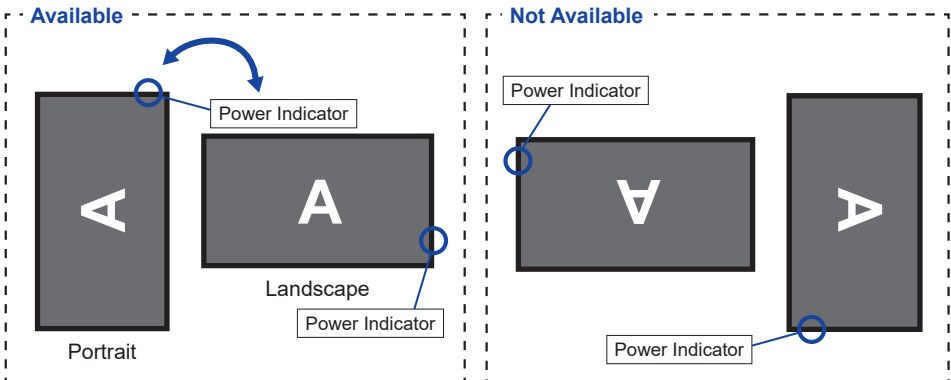

[PLACING THE STICKERS]

If you feel the screw holes are too visible in portrait mode, please use the stickers to cover them.

■ ProLite LH3254HS

Screw holes : 7



■ ProLite LH4354UHS

Screw holes : 9



■ ProLite LH5054UHS

Screw holes : 9



■ ProLite LH5554UHS

Screw holes : 7



■ ProLite LH6554UHS
Screw holes : 15

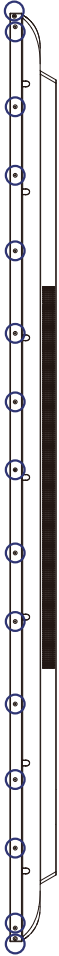

■ ProLite LH7554UHS
Screw holes : 9

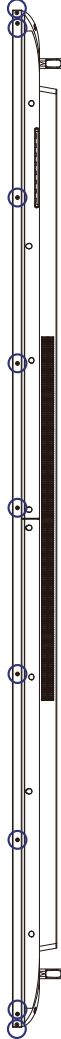

■ ProLite LH8654UHS
Screw holes : 13

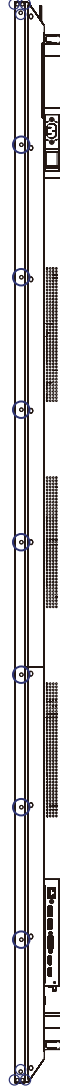

FUNCTIONS OF THE REMOTE CONTROL

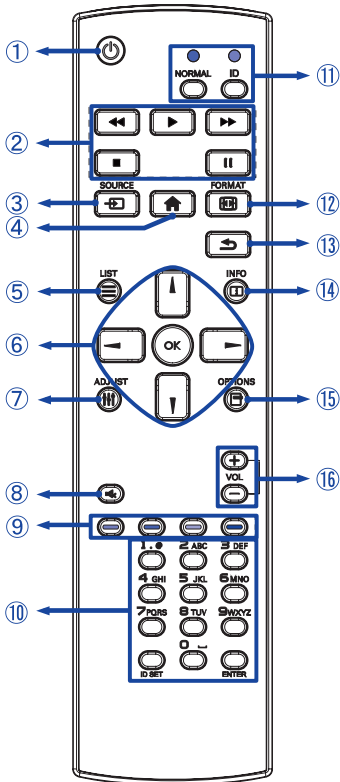

①		Turns the monitor ON and OFF.
②	[PLAY]	Control playback of media files. ▶ : Play ■ : Stop ⏸ : Pause ◀◀ : Quick-Return ▶▶ : Fast-Forward
③	SOURCE	Selects the source. Press ▲ or ▼ button to select from HDMI1, HDMI2, HDMI3, VGA, DVI-I, DisplayPort, SDM*, Browser, CMS, File Manager, Media Player, PDF Player or Custom. Press [OK] button to confirm and exit.
④		Opens the display's on-screen menu systems.
⑤		Return to the previous menu. Only Browser, Media Player and PDF Player inputs.
⑥		Navigates through submenus and settings. ▲ : Up Button ▼ : Down Button ◀ : Left Button ▶ : Right Button In Media Player: ◀ : Previous file ▶ : Next file In PDF Player: ◀ : Previous page ▶ : Next page
	OK	Confirms your selection or save changes.
⑦		Auto Adjust function only available when VGA input is selected.
⑧		Turns on or off the mute function when the Menu is not displayed.
⑨	COLOR	Not available on this model.
⑩	NUMBER/ ID SET/ ENTER	Enter text for network setting or ID setting.
⑪	ID Mode	ID: To enter ID Mode NORMAL: To leave ID Mode
⑫		Change picture format.
⑬		Returns to a previous menu or closes the OSD Menu.
⑭		Provides source and resolution information. Press the button for 6 seconds to unlock the remote control.
⑮		Display edit bar. Only Browser, Media Player and PDF Player inputs.
⑯	VOLUME - / +	VOLUME- : Decreases the sound volume. VOLUME+ : Increases the sound volume.

* Not available for ProLite LH3254HS

PREPARING THE REMOTE CONTROL

To use the remote control, insert the two dry batteries.

CAUTION

- Do not use any other batteries other than those specified in this manual for the Remote Control.
- Do not insert old and new batteries together in the Remote Control.
- Make sure that the terminals match the "+" and "-" indications in the battery compartment.
- Remove the dead batteries immediately to prevent them from liquid leaking into the battery compartment.
- Burst batteries or the electrolyte from these batteries may cause stains, fire or injury.

- ① Press and then slide the battery cover to open it.

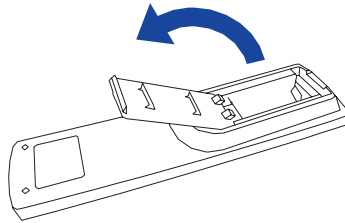

- ② Align and insert two AAA batteries according to their plus and minus ports (as indicated in the remote control).

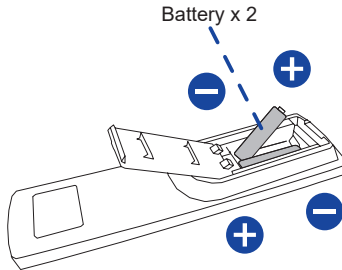

- ③ Replace the battery cover.

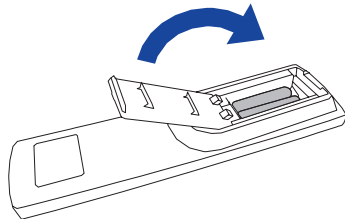

NOTE

- Refer to the above instructions when taking out the batteries.
- Replace with new batteries when the Remote Control does not work close to the monitor. Use AAA dry batteries. Risk of explosion if battery is replaced by an incorrect type.
- Operate the Remote Control by pointing it toward the Remote Sensor on the monitor.
- Other manufacturers remote control will not work with this monitor. Use the provided Remote Control ONLY.
- Used batteries needed to follow the city rule to be discarded. (suggestion: to dispose of used batteries please follow correct policy as per your council regulations)
- Batteries shall not be exposed to excessive heat such as sunshine, fire or the like.
- If you do not intend to use the remote control for a long period, remove the batteries.

ID REMOTE CONTROL

You can set the remote control ID when you want to use the remote control on specific monitors.

ID Mode (To enter ID Mode) : Press and hold the ID button until the red LED blinks twice.

Normal Mode (To leave ID Mode) : Press and hold the Normal button until the green LED blinks twice.

■ Programming ID Mode

To assign an ID to a remote control.

1. Enter ID Mode.
2. Press and hold the ID SET button until the red LED turned on.
3. Using the number button, input the desired ID. (01 - 255)
4. Press the ENTER button to confirm ID.
5. The red LED will blink twice when ID has been confirmed.

NOTE

- Not pressing any button within 10 seconds will exit the ID Mode.
- If an error pressing of buttons other than the digits occurred, wait 1 second after the red LED lights off and then lights up again, then press the correct digits again.
- To cancel or stop programming an ID, press the ID SET button.
- It is necessary to set up the ID number for each monitor before selecting its ID number.

■ Use ID Mode

1. Enter ID Mode.
2. Input the ID of the monitor which would like to control by number button.
3. Press the INPUT button.

BASIC OPERATION

■ Turning the monitor ON

The monitor is turned On and the Power Indicator turns to Green when you press the POWER button on the monitor or the Remote Control. The monitor is turned Off and the Power Indicator turns to Red when you press the POWER button on the monitor or the Remote Control. Press again to turn On the monitor.

NOTE

Even when using the standby mode or turning OFF the Power Switch, the monitor will consume a small amount of electricity. Disconnect the Power Cable from the power supply whenever the monitor is not in use or during the night, to avoid unnecessary power consumption.

[Monitor]

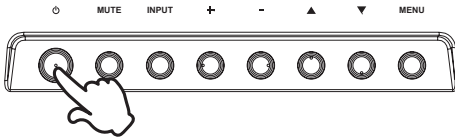

[Remote Control]

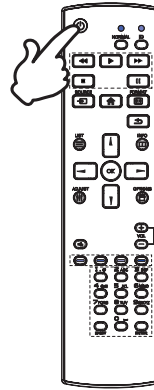

■ Display the adjustment menu page

The menu page appears on the screen when you press the MENU button on the monitor or the  HOME button on the Remote Control.

The menu page disappears when you press the  BACK button on the Remote Control again.

[Monitor]

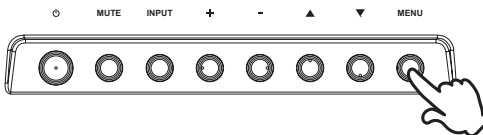

[Remote Control]

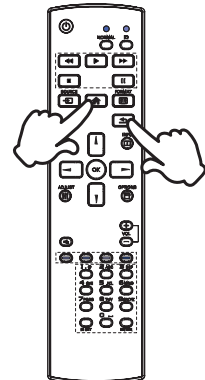

■ Move the cursor vertically

Select adjustment by pressing the ▲ / ▼ button on the monitor or the ▲ / ▼ button on the remote control while the menu page is displayed on the screen.

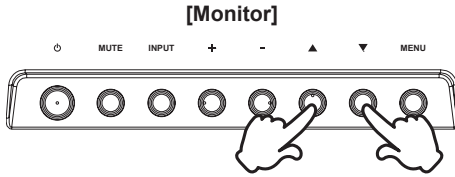

[Remote Control]

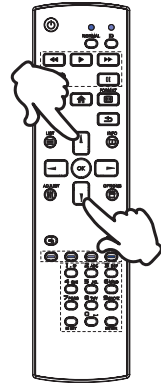

■ Move the cursor horizontally

Select menu or setting, or perform the adjustment by pressing the + / - button on the monitor or the ◀ / ▶ button on the remote control while the menu page is displayed on the screen.

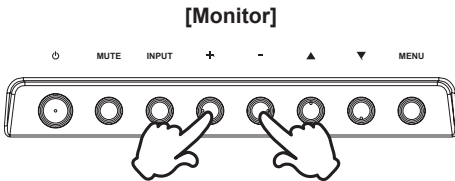

[Remote Control]

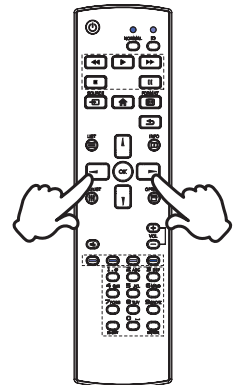

■ Adjust the volume of sound

Press the + / - button on the monitor or the remote control to adjust the volume of sound when the menu page is not displayed on the screen.

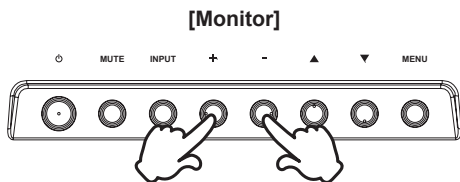

[Remote Control]

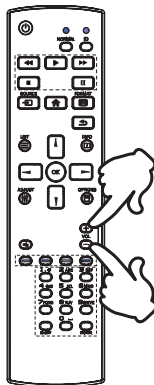

■ Switch the input signal

This is activated when you successively press the INPUT button on the monitor or the SOURCE button on the remote control.

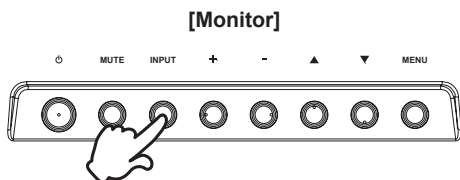

[Remote Control]

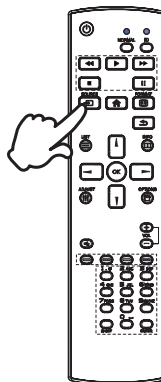

CONNECTING YOUR MONITOR : ProLite LH3254HS

- ① Ensure that both the computer and the monitor are switched off.
- ② Connect the computer to the monitor with the signal cable.
- ③ Connect the computer with the RS-232C Cable from the monitor.
- ④ Connect the Power Cable to the monitor first and then to the power source.
- ⑤ Turn on your monitor (Main Power Switch and Power Switch) and computer.

NOTE

- Make sure that the building installation has a circuit breaker of 120/240V, 20A (maximum).
- The signal cables used for connecting the computer and monitor may vary with the type of computer used. An incorrect connection may cause serious damage to both the monitor and the computer. The cable supplied with the monitor is for a standard connector. If a special cable is required please contact your local iiyama dealer or regional iiyama office.
- Make sure you tighten the finger screws at each end of the Signal Cable.
- The Class I pluggable equipment Type A must be connected to protective earth.
- The socket-outlet shall be installed near the equipment and shall be easily accessible.
- Excessive sound pressure from ear-/headphones can cause hearing damage/hearing loss.

[Example of Connection]

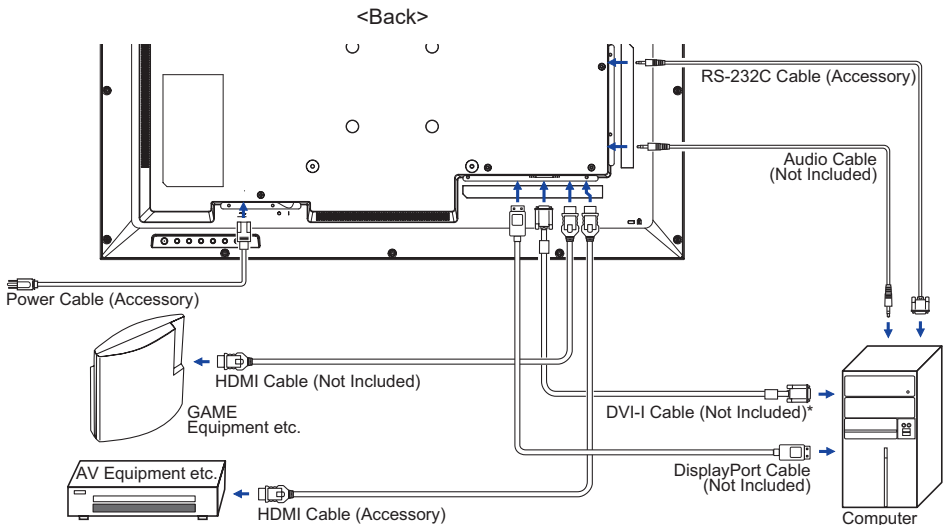

* DVI-I cable is not supplied with the monitor. If you use low quality DVI-I cable, it may cause a result of electro-magnetic interference. Please contact the iiyama Support Centre in your country if you wish to connect the monitor via the DVI input.

CONNECTING YOUR MONITOR : ProLite LH4354UHS / ProLite LH5054UHS / ProLite LH5554UHS / ProLite LH6554UHS

- ① Ensure that both the computer and the monitor are switched off.
- ② Connect the computer to the monitor with the signal cable.
- ③ Connect the computer with the RS-232C Cable from the monitor.
- ④ Connect the Power Cable to the monitor first and then to the power source.
- ⑤ Turn on your monitor (Main Power Switch and Power Switch) and computer.

NOTE

- Make sure that the building installation has a circuit breaker of 120/240V, 20A (maximum).
- The signal cables used for connecting the computer and monitor may vary with the type of computer used. An incorrect connection may cause serious damage to both the monitor and the computer. The cable supplied with the monitor is for a standard connector. If a special cable is required please contact your local iiyama dealer or regional iiyama office.
- Make sure you tighten the finger screws at each end of the Signal Cable.
- The Class I pluggable equipment Type A must be connected to protective earth.
- The socket-outlet shall be installed near the equipment and shall be easily accessible.
- Excessive sound pressure from ear/headphones can cause hearing damage/hearing loss.

[Example of Connection]

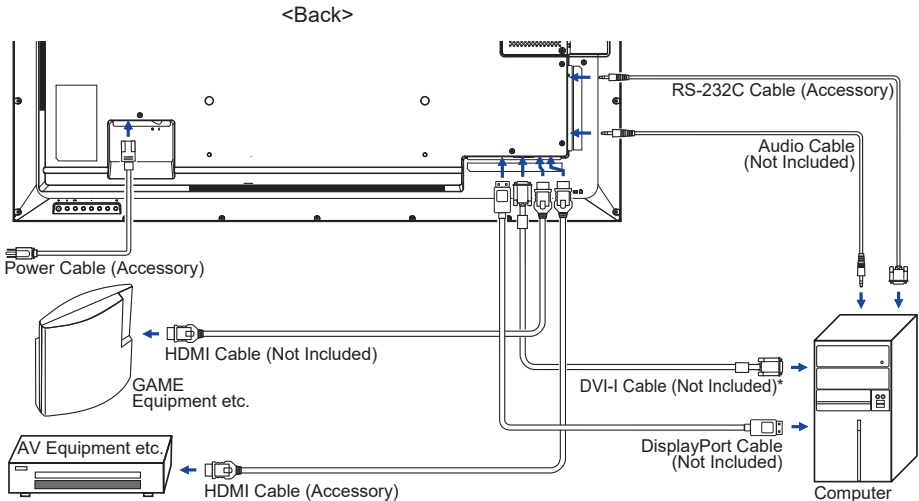

* DVI-I cable is not supplied with the monitor. If you use low quality DVI-I cable, it may cause a result of electro-magnetic interference. Please contact the iiyama Support Centre in your country if you wish to connect the monitor via the DVI input.

CONNECTING YOUR MONITOR : ProLite LH7554UHS / ProLite LH8654UHS

- ① Ensure that both the computer and the monitor are switched off.
- ② Connect the computer to the monitor with the signal cable.
- ③ Connect the computer with the RS-232C Cable from the monitor.
- ④ Connect the Power Cable to the monitor first and then to the power source.
- ⑤ Turn on your monitor (Main Power Switch and Power Switch) and computer.

NOTE

- Make sure that the building installation has a circuit breaker of 120/240V, 20A (maximum).
- The signal cables used for connecting the computer and monitor may vary with the type of computer used. An incorrect connection may cause serious damage to both the monitor and the computer. The cable supplied with the monitor is for a standard connector. If a special cable is required please contact your local iiyama dealer or regional iiyama office.
- Make sure you tighten the finger screws at each end of the Signal Cable.
- The Class I pluggable equipment Type A must be connected to protective earth.
- The socket-outlet shall be installed near the equipment and shall be easily accessible.
- Excessive sound pressure from ear-/headphones can cause hearing damage/hearing loss.

[Example of Connection]

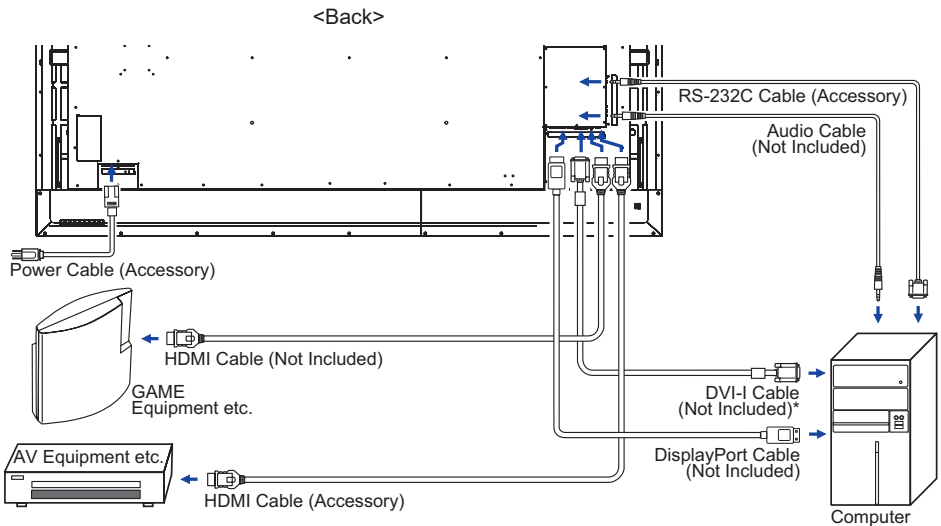

* DVI-I cable is not supplied with the monitor. If you use low quality DVI-I cable, it may cause a result of electro-magnetic interference. Please contact the iiyama Support Centre in your country if you wish to connect the monitor via the DVI input.

[Connection example with the peripheral device]

CAUTION

Turn off the power switch and unplug the monitor and peripherals before connection to avoid electric shock or damage.

NOTE

- Refer to the user manual of peripherals at the same time.
- Ensure you have the necessary cables as required.

■ ProLite LH3254HS

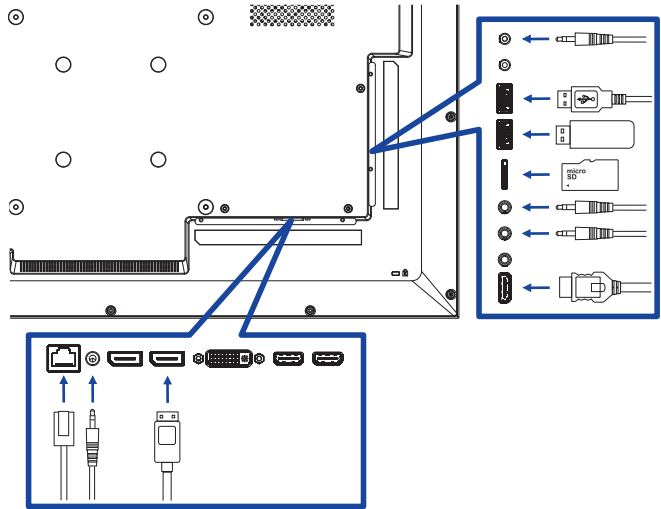

■ ProLite LH4354UHS ProLite LH5054UHS ProLite LH5554UHS ProLite LH6554UHS

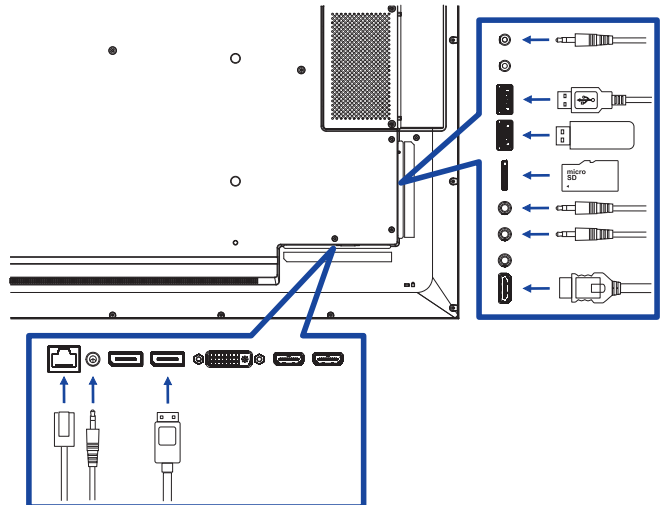

- ProLite LH7554UHS
- ProLite LH8654UHS

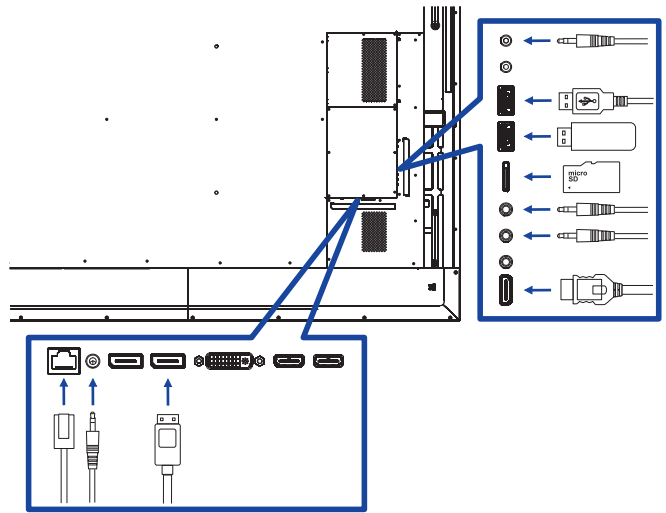

[About the daisy chain]

- Monitor control connection

RS-232C

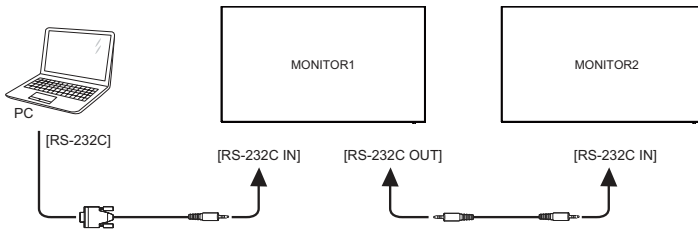

- Digital video connection

DisplayPort

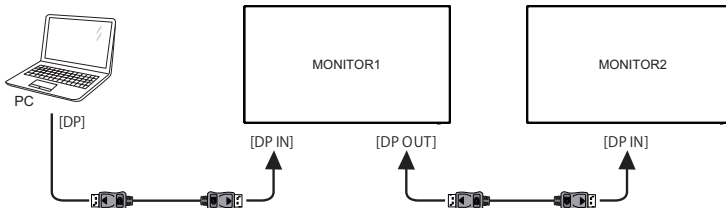

[To setup the network]

1. Switch on the router and switch on its DHCP setting.
2. Connect the router to this monitor with an Ethernet cable.
3. Press  HOME button and 1668 on the remote control, then select Settings.
4. Select "Network & internet", then press OK button.
5. Select "Ethernet", then press OK button.
6. Follow the on-screen instructions to install the network.

NOTE Connecting with a shielded CAT-5 Ethernet cable to comply with the EMC directive.

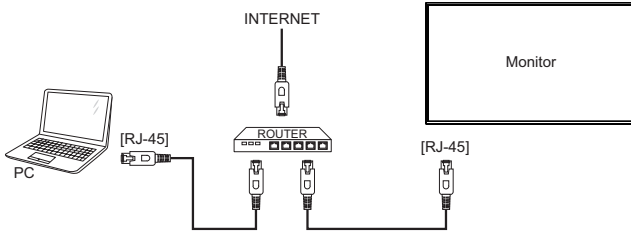

COMPUTER SETTING

■ Signal Timing

Change to the desired signal timing listed on page 67: COMPLIANT TIMING.

OPERATING THE MONITOR

To create the best picture, your iiyama LCD monitor has been preset at the factory with the COMPLIANT TIMING shown on page 67. You are also able to adjust the picture by following the button operation shown below. For more detailed adjustments, see page 51 for SCREEN ADJUSTMENTS.

- ① Press the **HOME** button on the remote control or the **MENU** button on the monitor to start the On Screen Display feature. There are additional Menu items which can be switched by using the **▲/▼/◀/▶** buttons on the remote control or the **▲/▼** buttons on the monitor.

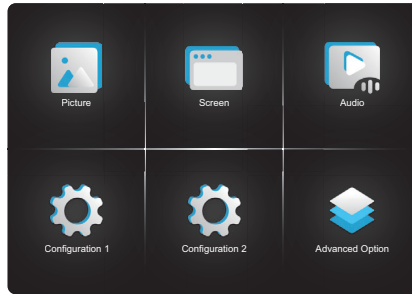

- ② Select the Menu item of the adjustment you want to make. Press the **OK** button on the remote control or the **INPUT** button on the monitor and enter the menu page. Then, use the **▲/▼** buttons on the remote control or the **▲/▼** buttons on the monitor to highlight the desired adjustment item.
- ③ Use the **◀/▶** buttons on the remote control or the **+/-** buttons on the monitor to make the appropriate adjustment or setting.
- ④ Press the **BACK** button on the remote control or the **MENU** button on the monitor to leave the menu, and the settings you just made would be automatically saved.

For example, to correct for vertical position, select Menu item of "Screen". Press the **OK** button on the remote control or the **INPUT** button on the monitor. Then, select "V Position" by using the **▲/▼** buttons on the remote control or the **▲/▼** buttons on the monitor.

Use the **◀/▶** buttons on the remote control or the **+/-** buttons on the monitor to change the vertical position settings. The vertical position of the overall monitor should be changing accordingly while you are doing this.

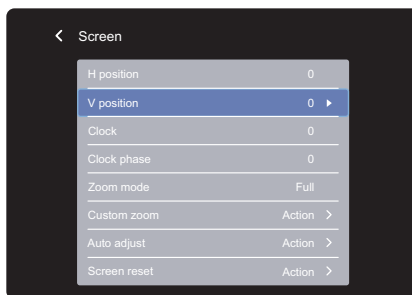

Press the **BACK** button on the remote control or the **MENU** button on the monitor lastly, it ends, all changes are saved in the memory.

NOTE

- The  BACK button on the remote control or the MENU button on the monitor can be used to return previous menu item.
- Any changes are automatically saved in the memory when the On Screen Display disappears. Turning off the power should be avoided while using the Menu.
- Adjustments for H/V Position, Clock and Clock phase are saved for each signal timing. Except for these adjustments, all other adjustments have only one setting which applies to all signal timings.

ADJUSTMENT MENU CONTENTS



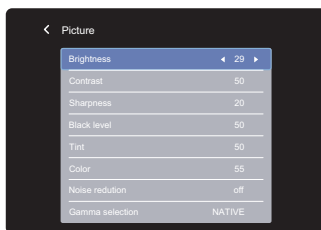

Picture

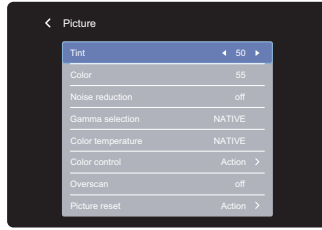

Adjustment Item	Problem / Option		Button to Press	
Brightness* ¹	Too dark Too bright		 	
Contrast* ²	Too dull Too intense		 	
Sharpness* ²	Too soft Too sharp		 	
Black level* ²	Black is too dark Black is too bright		 	
Tint* ²	Purplish Greenish		 	
Color* ²	Too weak Too strong		 	
Noise reduction* ²	Off	Noise Reduction is turned off.		
	Low	Electronic image noise caused by different media players is reduced.		
	Middle	Electronic image noise caused by different media players is reduced more than Low.		
	High	Electronic image noise caused by different media players is reduced more than Medium.		
Gamma selection* ²	You can set the Gamma. Native / 2.2 / 2.4 / Sgamma / D-image			
Color temperature	3000°K	9300°K		
	4000°K	10000°K		
	5000°K	Native	Original color temperature	
	6500°K	User1	User preset 1	
	7500°K	User2	User preset 2	

Picture











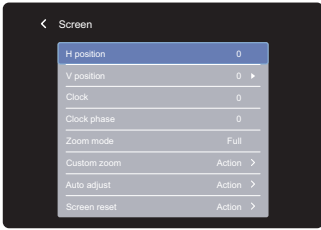

Adjustment Item	Problem / Option		Button to Press
Color control* ³	Set user color.		
	User1	R	Too weak Too strong
		G	
		B	
User2	2000K-10000K		
Overscan* ²	Off	Over scan is turned off.	   
	On	Display area about 95%.	
Picture reset	Cancel	Return to Menu.	
	OK	Picture setting will be restored to factory-preset data.	

*¹ Adjust the Brightness when you are using the monitor in a dark room and feel the screen is too bright.

Brightness adjustment is disabled when Brightness of Panel saving is on.

*² Not available for Media Player, Browser, CMS, PDF Player and Custom inputs.

*³ It can be chose only when Color temperature is set to "User1/User2".

Screen			
Adjustment Item	Problem / Option		Button to Press
H Position* ¹	 Too left  Too right		
V Position* ¹	 Too low  Too high		
Clock* ^{1,2}	 Too narrow  Too wide		
Clock Phase* ^{1,2}	To correct flickering text or lines		
Zoom mode* ³	Full	Enlarge the picture horizontally to fill the screen if the picture source is 4:3 (standard definition). When the picture source is 16:9 (high definition), it is not scaled.	
	4:3	Display all pictures in 4:3 aspect ratio.	
	Real	Display the picture dot by dot.	
	21:9	Display all pictures in 21:9 aspect ratio.	
	Custom	Customize zoom screen.	
Custom zoom* ⁴	Zoom	Zoom the horizontal and vertical size of the image simultaneously.	
	H zoom	Zoom the horizontal size of the image.	
	V zoom	Zoom the vertical size of the image.	
	H position* ⁵	Zoom / H Zoom values.	
	V position* ⁵	Zoom / V Zoom values.	
Auto adjust* ^{1,6}	Adjust Position, Clock and Clock Phase automatically.		
Screen reset	Cancel	Return to Menu.	
	OK	Screen setting will be restored to factory-preset data.	

*¹ Only VGA input.

*² See page 51 for SCREEN ADJUSTMENTS.

*³ Not available for Media Player, Browser, CMS, PDF Player and Custom inputs.

*⁴ It can be chose only when Zoom mode is set to "Custom".









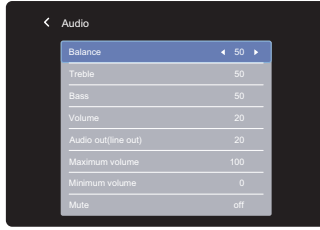

















*⁵ When the value of Zoom, H zoom and V zoom is "0", H position and V position cannot be adjusted.

*⁶ For best results, use the Auto Adjust in conjunction with the adjustment pattern.

See page 51 for SCREEN ADJUSTMENTS.

Audio



Adjustment Item	Problem / Option		Button to Press
Balance	Left side speaker is louder. Right side speaker is louder.		 
Treble	Too weak Too strong		   
Bass	Too weak Too strong		   
Volume	Too soft Too loud		   
Audio out (line out)	Adjust audio output volume. Too soft Too loud		   
Maximum volume	Set the maximum volume.		   
Minimum volume	Set the minimum volume.		   
Mute	Off	Return the sound volume to the previous level.	
	On	Turn off the sound temporarily.	
Audio source*	Analog	Select the DVI/VGA input.	
	Digital	Select the HDMI/DisplayPort input.	
Audio reset	Cancel	Return to Menu.	
	OK	Audio setting will be restored to factory-preset data.	
Audio out sync	Off	The speaker volume is different from the audio out (line-out) volume.	
	On	The speaker volume is consistent with the audio out (line-out) volume.	
Speaker Setting	Off	Disable the built-in speaker.	
	On	Enable the built-in speaker.	

* Not available under Android.

Configuration1

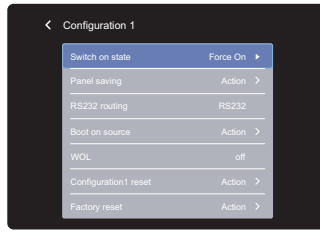









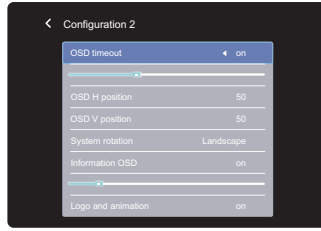



Adjustment Item	Problem / Option		
Switch on state	Forced on	The monitor will turn on when the power cord is connected to a wall outlet.	
	Power off	The monitor will remain off when the power cord is connected to a wall outlet.	
	Last status	The monitor will return to the previous power status (on/off/standby) when removing and replacing the power cord.	
Panel saving	Brightness	Off	Backlight adjustment is off.
		On	The image brightness will be reduced to 40% of the maximum.
	Pixel shift	For the monitor to slightly shift the position of pixels in four directions (up, down, left or right).	
		Auto	Move the position of the image automatically.
		Off	Pixel shift is turned off.
On	Move the position of the image at set intervals. 10 - 900 seconds		
RS232 routing	Select the RS232 control port. RS232 / LAN RS232		
Boot on source*1	Last input	When the power is turned on, it starts with the same setting as when the power was last turned off. Off / On	
	Input	Select input source when boot up. HDMI1 / HDMI2 / HDMI3 / VGA / DVI-I / DisplayPort / SDM*2 / Browser / CMS / File Manager / Media Player / PDF Player / Custom	
	Playlist	Select playlist index for Browser, Mediaplayer and PDF player.	
WOL	Off	Disable wake on LAN function.	
	On	Enable wake on LAN function.	
Configuration1 reset	Cancel	Return to Menu.	
	OK	Configuration1 setting will be restored to factory-preset data.	
Factory reset	Cancel	Return to Menu.	
	OK	Factory-preset data is restored.	

*1 No failover function, system will keep source even the source is no signal input.

*2 It can be used only when SDM-S/SDM-L is installed.

Configuration2



Adjustment Item	Problem / Option		Button to Press
OSD timeout	You can set the OSD display duration time between 5 and 120 seconds. Off / 5 - 120 seconds		 
OSD H position	OSD is too left OSD is too right		   
OSD V position	OSD is too low OSD is too high		   
System rotation	Landscape	Display the OSD in Landscape mode.	
	Portrait	Display the OSD in Portrait mode.	
Information OSD	Set the period of time the information OSD is displayed on the upper right corner of the screen. Off / 1 - 60 seconds		 
Logo and animation	Off	iiyama Logo and animation does not display when the monitor is turned on.	
	On	iiyama Logo and animation display when the monitor is turned on.	
	User	Custom logo option in android is set, there will be only custom logo when the monitor is turned on.	
Logo setting* ¹	Select boot logo.		
Animation setting* ¹	Select boot animation.		
Monitor ID	Set ID to the monitor. 1 - 255		
Group ID	Set group to the monitor. 1 - 254		

Configuration2

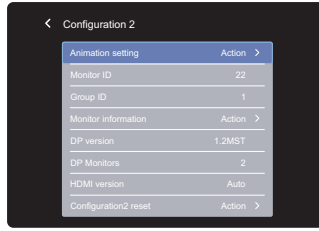

Adjustment Item	Problem / Option	
Monitor information	Shows information about your monitor, including Model name, Serial No., Operation hours and SW version.	
DP version* ²	Set the version of the DisplayPort. 1.1 / 1.2SST / 1.2MST	
DP Monitors* ²	Set up multiple monitors with DisplayPort. 2 / >2	
HDMI version* ³	Set the version of the HDMI. 2.0 / 1.4 / Auto	
Configuration2 reset	Cancel	Return to Menu.
	OK	Configuration2 setting will be restored to factory-preset data.





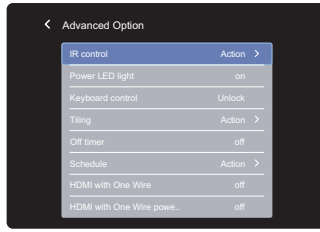

*¹ The Logo setting and Animation setting are only available when you select "User" of Logo and animation function.

*² Suitable for DisplayPort input only.

*³ Suitable for HDMI input only.

Advanced option



Adjustment Item	Problem / Option		Button to Press
IR control	Select the operation mode of the remote control when multiple monitors are connected via an RS232C connection.		
	Unlock* ¹	Unlock the remote control.	
	Lock All	Lock all of the remote control.	
	Lock all but Power	Lock all except the power of the remote control.	
	Lock all but Volume	Lock all except the volume of the remote control.	
	Lock all except PWR & VOL	Lock all except the volume and power of the remote control.	
	Primary	Set the monitor as the primary monitor for remote control operation.	
	Secondary	Set the monitor as the secondary monitor. This monitor can not be operated by the remote control, and will only receive the control signal from the primary monitor via the RS232C connection.	
Power LED light	Off	The Power Indicator is turned Off.	
	On	The Power Indicator is turned On.	
Keyboard control	Lock the keyboard function. (Control buttons)		
	Unlock* ²	Unlock the keyboard.	
	Lock All	Lock all of the keyboard.	
	Lock all but Volume	Lock all except the volume of the keyboard.	
	Lock all but Power	Lock all except the power of the keyboard.	
Tiling * ³	H monitors	Sets the number of monitors used in the horizontal position.	 
	V monitors	Sets the number of monitors used in the vertical position.	 
	Position	Sets the position of the screen matrix.* ⁴	 

Advanced option

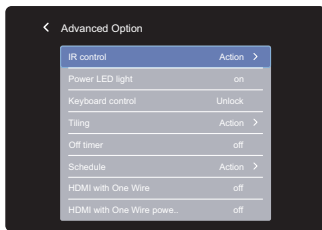

Adjustment Item	Problem / Option		Button to Press
Tiling ^{*3}	Frame comp. Top	The monitor will adjust the image to compensate for the width of the monitor bezels in order to accurately display the image.	
	Frame comp. Bottom		
	Frame comp. Left		
	Frame comp. Right		
	Frame comp. Enable	Off	Frame compensation. Enable is turned off.
		On	Enable Frame compensation.
	Enable	Off	Enable is turned off.
On		The monitor will apply the settings in "H monitors", "V monitors", "Position" and "Frame comp.".	
Switch on delay	Adjust the power-on delaying time (in seconds) allows a sequential powering-on for each monitor by their ID number when multiple monitors are connected. Off(0) / Auto / On(2 - 255) seconds		

*1 To unlock, press and hold the INFO button on the remote control for 6 seconds.

*2 To unlock, press the +, -, and - button on the monitor in this sequence.

*3 With this function you can create a single large-screen matrix (video wall) that consists of up to 150 sets of this monitor (up to 10-sets on the vertical and 15-sets on the horizontal sides). However, the image quality may be degraded, display speed may be slowed down, or noise may occur and pictures may not be displayed correctly. It is recommended that the screen matrix be set to a maximum of 5 x 5 screen configurations (25 monitors).

*4 Screen Matrix

Example: 2 x 2 screen matrix (4 monitors)
H monitors = 2 monitors
V monitors = 2 monitors

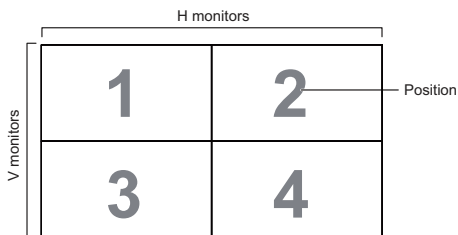

Example: 5 x 5 screen matrix (25 monitors)
H monitors = 5 monitors
V monitors = 5 monitors

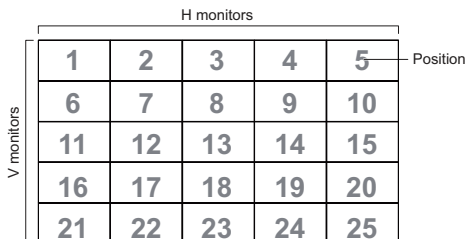

Advanced option

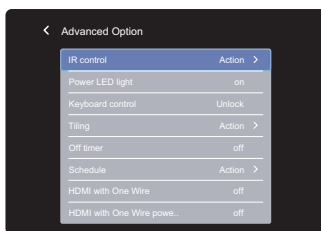

Adjustment Item	Problem / Option	
Off Timer	Set when turn off the monitor. Off / 1 - 24 hours	
Schedule	Schedule list	Up to 7 schedules can be set.
	Start time * ⁵	Set start time.
	End time * ⁵	Set end time.
	Input	Select default input source to use when the monitor is automatically turned on next time. HDMI1 / HDMI2 / HDMI3 / VGA / DVI-I / DisplayPort / SDM* ⁶ / Browser / CMS / File Manager / Media Player / PDF Player / Custom
	Playlist	Choose playlist for the mediaplayer, PDF player and browser.
	Days of the week	Set the day of the week. SUN / MON / TUE / WED / THU / FRI / SAT
	Every week	Set whether to repeat every week. Off / On
	Enable* ⁷	Enable / disable schedule.
HDMI with One Wire	Off	HDMI with One Wire is turned off.
	On	Control all devices connected by HDMI cable with one remote control.
HDMI with One Wire Power Off	Off	HDMI with One Wire Power Off is turned off.
	On	Use the power button on the device connected with the HDMI cable to switch to standby mode.
Auto signal detection * ⁸	Off	Disable the Auto signal detection.
	All * ⁹	Detects all sources automatically if there is no signal on the default input and selects the available signal automatically.
	Failover	Detects sources automatically with user-defined order if there is no signal on the default input and selects the available signal automatically.

*⁵ The start time in the Schedule must be less than the end time.

*⁶ It can be used only when SDM-S/SDM-L is installed.

*⁷ Adjustments to "Enable" should be made only after Start time, End time, Input and week have been correctly set.

*⁸ The display detects and select available signal source automatically.

*⁹ Order of detection: HDMI1 → HDMI2 → HDMI3 → VGA → DVI → DP → SDM → Browser → CMS → File Manager → Media Player → PDF Player → Custom

Advanced option

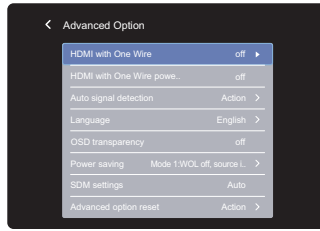

Adjustment Item	Problem / Option			Button to Press
Language	English	English	Deutsch	German
	Français	French	Italiano	Italian
	Español	Spanish	Русский	Russian
	Polski	Polish	Nederlands	Dutch
	Česky	Czech	Dansk	Danish
	Svenska	Swedish	Suomi	Finnish
	Norsk bokmål	Norwegian		
OSD Transparency	The background of OSD is made transparent. Off / 5 - 100			
Power saving	Mode1: WOL off, source input wake-up off, Backlight off Mode2: WOL off, source input wake-up on, Backlight off Mode3: WOL on, source input wake-up off, Backlight off Mode4: WOL on, source input wake-up on, Backlight off			
SDM settings* ¹⁰	Auto	When turning on the display power and switching input source to SDM, SDM power is automatically turned on.		
	Always off	SDM is turned Off. NOTE You need to turn it on manually and when the display power is turned off, SDM is turned off.		
	Always on	SDM is always turned On.		
Advanced option reset	Cancel	Return to Menu.		
	OK	Advanced option setting will be restored except "Date and Time" in the Advanced option menu to factory-preset data.		

*¹⁰Only SDM input.

APPLICATION

Press the  HOME button and number 1668 on the remote control.

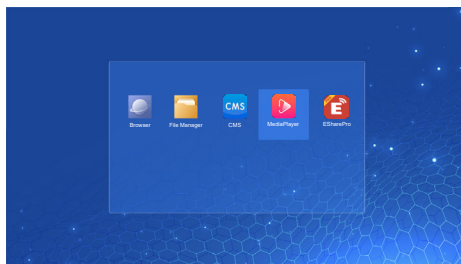
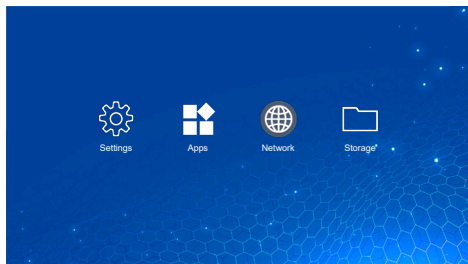

<Settings>



Adjustment Item	Problem / Option	
Wi-Fi	Set the wifi function Enable / disable and pairing to WiFi device.	
	Wifi list	Display a list of WiFi networks
	Add network	Network name
		Security
		Advanced options
	Wifi preferences	Turn on wifi automatically
Notify for public networks		
Advanced		
Saved networks	Save wifi networks on this monitor.	
Ethernet	Set the wired network. On / Off	
	IP address	Assign IP adress for this monitor.
	Netmask	Assign Netmask for this monitor.
	Gateway	Assign Gateway for this monitor.
	DNS1	Assign DNS server address.
	DNS2	
	Ethernet IP mode	Static
DHCP		
Hotspot	Wifi hotspot	Set the Hotspot function. Disable / Enable (Hotspot name / security / hotspot password / AP Band / Turn off hotspot automatically)

Apps & Notification



Adjustment Item	Problem / Option	
App info	Display all applications.	
Default apps	Browser app	Set the default apps.
	Home app	
	Opening links	
Permission manager	App permissions	Set app permissions.

Display

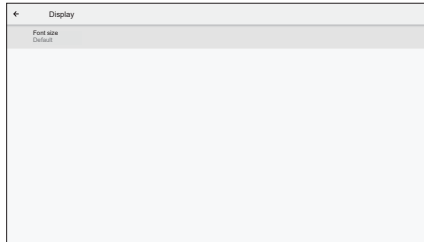

Adjustment Item	Problem / Option	
Font size	Small	Set the font size.
	Default	
	Large	
	Largest	

Signage display

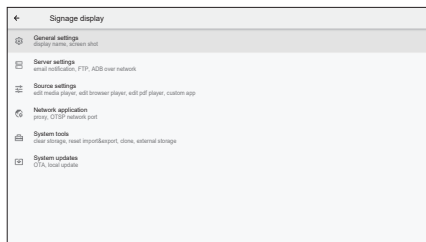

Adjustment Item	Problem / Option		
General settings	Signage display name	Set the monitor name.	
	Screenshot	Disable / Enable(Interval, Start time, End time, Repeat, Save to, Purge Screenshots, Send screenshots via email)	
Server settings	Email Notification	Disable / Enable(SMTP, Manager Email, Test)	
	FTP	Disable / Enable(Account, Password, Storage Path, Port)	
	ADB over network	Access network connection with port 5555.	
Source settings	Edit Media Player	Edit Media Player playlist and effect settings.	
	Edit Browser Player	Edit Browser list and effect settings.	
	Edit PDF Player	Edit PDF Player playlist and effect settings.	
	Storage path	Set the Media player, PDF player, Browser storage location.	
	Custom app	Edit the Custom app.	
Network application	Proxy	Set the proxy server. Disable / Enable (Hostname: Proxy server IP Adress, Port: Proxy server port number, Type: Proxy server type) Authentication / Username / Password	
System tools	Clear Storage	Clear all data in signage folders. All / Internal storage / SD card / USB storage	
	Reset	Erase all data	Factory-preset data is restored.
	Clone and Import	Clone	Copy the media file from internal, USB or SD folder.
		Import	Import from signage folder under USB/SD. Internal storage
	SD card / USB external storage Lock	Disable	SD card / USB External Storage unlock.
Enable		SD card / USB External Storage lock.	
System updates	OTA	Firmware update.	
	Local update		

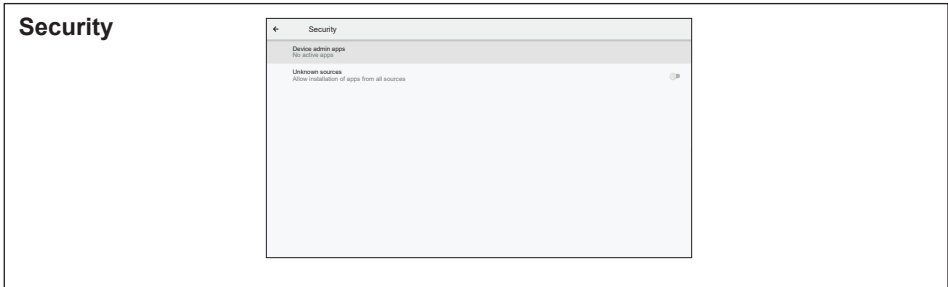

Adjustment Item	Problem / Option
Device admin apps	Display credential storage information.
Unknown sources	Disable / Enable installation of apps from unknown sources.

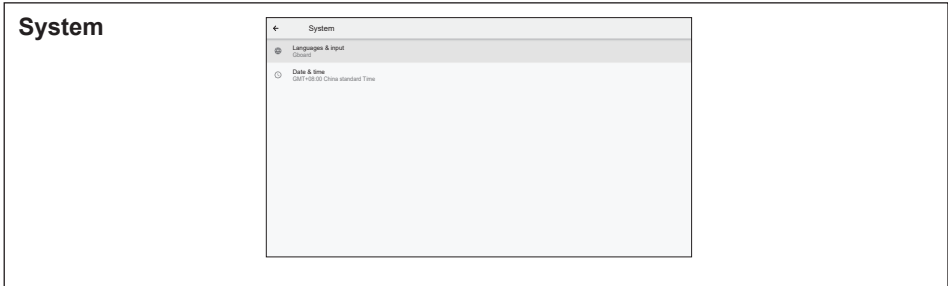

Adjustment Item	Problem / Option	
Language & Input	Languages	Set display language, keyboard and input method. Language: English / Deutsch / Français / Italiano / Español / Русский / Polski / Nederlands / Český / Dansk / Svenska / Suomi / Norsk bokmål
	On-screen keyboard	
	Physical keyboard	
Date & time	Use network-provided time	Set the Date and Time. Use 24-Hour Format, Automatic Date & Time, Date Format, Timezone.
	Ntp server	

About device												
												
Adjustment Item	Problem / Option											
Legal information	<table border="1"> <tr> <td>Third-party licenses</td> <td rowspan="10"> Main info in About: Legal / Model / Android version / Build number / Build version Automatically search update .zip from USB or SD card. When you select the updated .zip file, the monitor will restart and the update will start. </td> </tr> <tr> <td>System Webview licenses</td> </tr> <tr> <td>Model</td> </tr> <tr> <td>Serial number</td> </tr> <tr> <td>Hardware version</td> </tr> <tr> <td>Android version</td> </tr> <tr> <td>Android security update</td> </tr> <tr> <td>Kernel version</td> </tr> <tr> <td>Build number</td> </tr> <tr> <td>Build version</td> </tr> </table>	Third-party licenses	Main info in About: Legal / Model / Android version / Build number / Build version Automatically search update .zip from USB or SD card. When you select the updated .zip file, the monitor will restart and the update will start.	System Webview licenses	Model	Serial number	Hardware version	Android version	Android security update	Kernel version	Build number	Build version
Third-party licenses	Main info in About: Legal / Model / Android version / Build number / Build version Automatically search update .zip from USB or SD card. When you select the updated .zip file, the monitor will restart and the update will start.											
System Webview licenses												
Model												
Serial number												
Hardware version												
Android version												
Android security update												
Kernel version												
Build number												
Build version												
Model												
Android version												
Build number												
Build version												

■ Quick Info

Press the Info button and number 77 on the remote control.
 Display the Network and Monitor etc. information.

<Android> * Android upgrade is not available on this model.

- Settings : Go to settings app.
- Apps : Show all apps. (Browser/File Manager/CMS/Media Player/ESharePro)
- Network : Set Ethernet.
- Storage : Display current Android storage information.

NOTE

■ Supported file system:

FAT32

■ Supported file format:

- Music: MP3, M4A, AAC, LPCM
- Video: 3G2, 3GP, AVI, F4V, FLV, MP4, M2TS, M2V, M4V, MKV, MOV, MPEG, MTS, OGM, PMP, TP, TS, VOB, WEBM
- Photo: JPG, JPEG, BMP, PNG, GIF

[Media Player]

- Play file: Select the file to play
- Play order: Set the play order of the files
- Play mode: Set the playback mode
- Picture style: Set the picture size
- Create list: Create a new playlist
- Play list: Edit playlist

● Play file

1. Select "Play file" on the page.
2. Select the file and press OK button.
Multiple files can be selected.
3. Press the "Open" button to play.

■ Media Hotkey

- ► **Play**: To play the media file.
- || **Pause**: To pause the media file.
- ►► **Fast forward**: To skip forward 10 seconds.
- ◀◀ **Rewind**: To skip backward 10 seconds.
- ■ **Stop**: To stop the playing file and return to Menu.

■ Arrow key

- ◀ : Previous file
- ▶ : Next file

● Play order

Select "Play order" on the page.

- **Sequences**: Play files in sequences.
- **Reverse**: Play files in reverse.
- **Random**: All files in the list play randomly.
- **Cycle**: All files in the list play repeatedly.

● Play mode

Select "Play mode" on the page.

- **Auto**: Autoplay duration(s). 5s / 15s / 30s / 60s
- **Manual**: Play the file manually.

● Picture style



Select "Picture style" on the page.

- **Scale**: Display the image in its original aspect ratio.
- **Full**: Enlarge the image to full screen

● Create list

1. Select "Create list" on the page.
2. Select "Add file".
3. Select the file and add to the list.



- Edit bar
 - **Move up:** Move the files to the top of the list.
 - **Move down:** Move the files to the bottom of the list.
 - **Delete:** Delete files.
 - **Delete all:** Delete all playlist files.
 - **Back:** Return.

- Remote control
 -  **Option key:** Display edit bar
 -  **OK key:** Select / deselect file

● Play list

1. Select "Play list" on the page.
2. Press the  Option button on the remote control to open the edit bar.
3. Add the file or edit the file.

- Edit bar
 - **Move up:** Move the files to the top of the list.
 - **Move down:** Move the files to the bottom of the list.
 - **Delete:** Delete files.
 - **Delete all:** Delete all playlist files.
 - **Back:** Return.

- Remote control
 -  **Option key:** Display edit bar
 -  **OK key:** Select / deselect file

[Browser]

● New tab

1. Select "New tab" on the page.
2. Enter URL and press OK to access.



● Create list

1. Select "Create list" on the page.
2. Enter URL and add to the list.

● Play list

1. Select URL on the page.
2. Press the  Option button on the remote control to open the edit bar.
3. Edit URL

- Edit bar
 - **Delete:** Delete a URL.
 - **Delete all:** Delete all URL record.
 - **Back:** Return.

- Remote control
 -  **Option key:** Display edit bar
 -  **Play key:** Open the web page
 -  **OK key:** Select / deselect

[PDF Player]

● Play file

1. Select "Play file" on the page.
2. Select the file and press OK button.
Multiple files can be selected.
3. Press the "Open" button to play.

■ Media Hotkey

- ► **Play**: To play the PDF file.
- || **Pause**: To pause the PDF file.
- ■ **Stop**: Return.

■ Arrow key

- ◀ : Previous page
- ▶ : Next page

● Play order

Select "Play order" on the page.

- **Sequences**: Play files in sequences.
- **Reverse**: Play files in reverse.
- **Random**: All files in the list play randomly.
- **Cycle**: All files in the list play repeatedly.

● Play mode

Select "Play mode" on the page.

- **Auto**: Autoplay duration(s). 5s / 15s / 30s / 60s
- **Manual**: Adjust the file manually.



● Create list

1. Select "Create list" on the page.
2. Select "Add file".
3. Select the file and add to the list.

■ Edit bar

- **Move up**: Move the files to the top of the list.
- **Move down**: Move the files to the bottom of the list.
- **Delete**: Delete files.
- **Delete all**: Delete all playlist files.
- **Back**: Return.

■ Remote control

-  **Option key**: Display edit bar
-  **OK key**: Select / deselect file



● Play list

1. Select "Play list" on the page.
2. Press the  Option button on the remote control to open the edit bar.
3. Add the file or edit the file.

■ Edit bar

- **Move up:** Move the files to the top of the list.
- **Move down:** Move the files to the bottom of the list.
- **Delete:** Delete files.
- **Delete all:** Delete all playlist files.
- **Back:** Return.

■ Remote control

-  **Option key:** Display edit bar
-  **OK key:** Select / deselect file

[File Manager]

Browse the files stored in the internal storage, USB and SD card.

[EShare Pro]

EShare is a multiscreen interaction application which makes the user experience natural and enjoyable for home entertainment, business presentation, and educational training.

SCREEN ADJUSTMENTS

Adjust the image by following the procedure below to get the desired picture when selecting Analog input.

- The screen adjustments described in this manual are designed to set image position and minimize flicker or blur for the particular computer in use.
- The monitor is designed to provide the best performance at resolution of 3840 × 2160, but can not provide the best at resolutions of less than 3840 × 2160 because the picture is automatically stretched to fit the full screen. It is recommended to operate at resolution of 3840 × 2160 in normal use.
- Displayed text or lines will be blurred or irregular in thickness when the picture is stretched due to the screen enlargement process.
- It is preferable to adjust the image position and frequency with the monitor controls, rather than the computer software or utilities.
- Perform adjustments after a warm-up period of at least thirty minutes.
- Additional adjustments may be required after the Auto Adjust depending on the resolution or signal timing.
- The Auto Adjust may not work correctly when displaying the picture other than the screen adjustment pattern. In this case, manual adjustments are required.

There are two ways to adjust the screen. One way is automatic adjustment for Position, Clock and Clock phase. The other way is performing each adjustment manually.

Perform the Auto Adjust first when the monitor is connected to a new computer, or resolution is changed. If the screen has a flicker or blur, or the picture does not fit in the display area after performing the Auto Adjust, manual adjustments are required. Both adjustments should be made by using the screen adjustment pattern (Test.bmp) obtained via the iiyama web site (<https://iiyama.com>). Adjust the image by following the procedure below to get the desired picture.

This manual explains adjustment under Windows® OS.

- ① **Display the picture at the optimum resolution.**
- ② **Enter the Test.bmp (screen adjustment pattern) to wallpaper.**

NOTE

- Consult the appropriate documentation for doing this.
- Set the display position to center in the wallpaper setting dialogue box.

[Adjustment pattern]

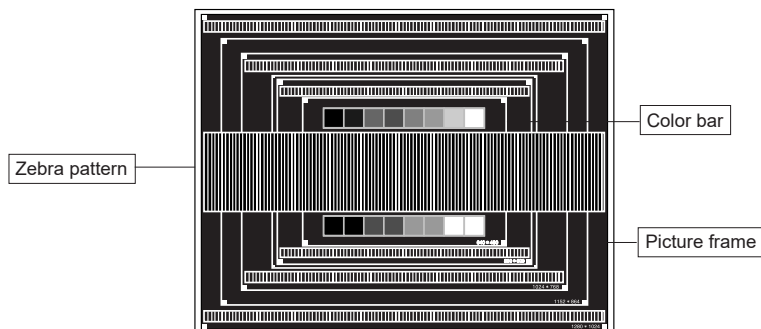

- ③ Adjust the Auto Adjustment. (Auto Adjust)
- ④ Adjust the image manually by following procedure below when the screen has a flicker or blur, or the picture does not fit in the display area after performing the Auto Adjust.
- ⑤ Adjust the V Position so that the top and bottom of the picture frame will fit to the display area.

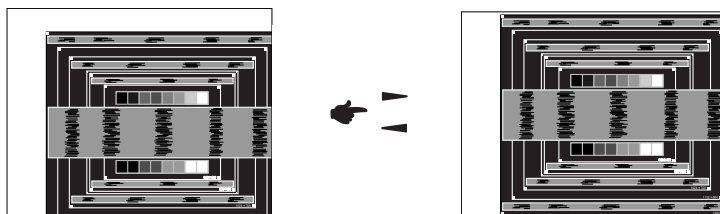

- ⑥ 1) Adjust the H Position so that the left side of the picture frame will move to the left edge of the display area.

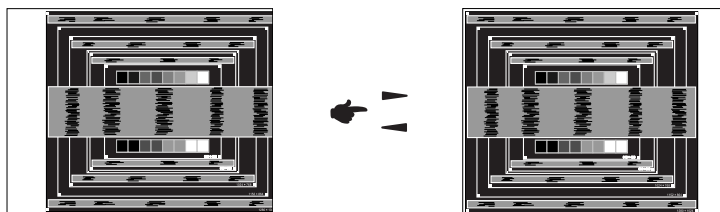

- 2) Stretch the right side of the picture frame to the right edge of the display area by adjusting the Clock.

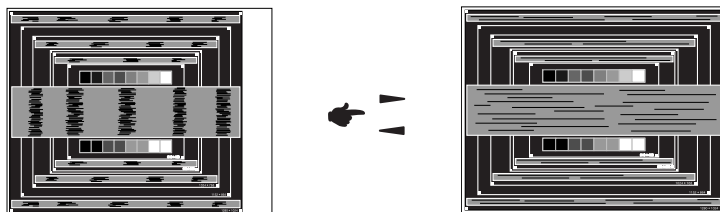
**NOTE**

- When the left side of the picture frame moves apart from the left edge of the display area during the Clock adjustment, adjust steps 1) and 2).
- Another way to make the Clock adjustment is to correct the vertical wavy lines in the zebra pattern.
- The picture may flicker during the Clock, H Position and V Position adjustment.
- In case the picture frame is bigger or smaller than the data display area after the Clock adjustment, repeat steps from ③.

- ⑦ Adjust the Clock phase to correct horizontal wavy noise, flicker or blur in the zebra pattern.

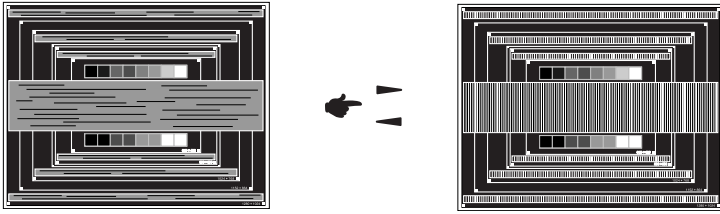

NOTE

- In case the strong flicker or blurs remain on a part of the screen, repeat steps ⑥ and ⑦ because the Clock may not be adjusted correctly.
- Adjust the H Position after the Phase adjustment if the horizontal position moves during the adjustment.

- ⑧ Adjust the Brightness and Color to get the desired picture after you complete the Clock and Clock phase adjustments.

Put back your favorite wallpaper.

STANDBY FEATURE

This product features the standby function. When activated, it automatically reduces unnecessary power consumption of the monitor when your computer is not in use.

There is a standby step the monitor takes as described below. The standby function, including any timer settings is configured by the operating system. Check your operating system manual for information on how this can be configured.

■ Standby Mode

When the video signal from the computer is off, the monitor enters into Standby Mode which reduces the power consumption to less than 0.5W*. The screen becomes dark, and the power indicator turns to red. From Standby Mode, the image reappears in several seconds when either the keyboard or the mouse are touched again.

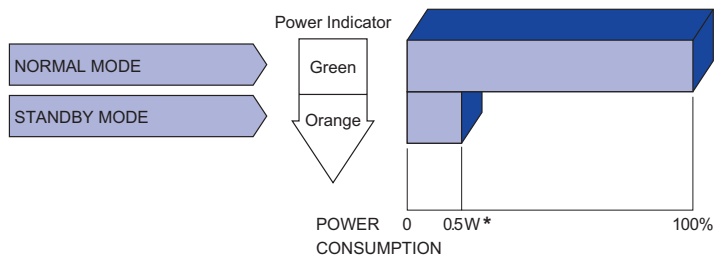

* When the USB devices are not connected.

TROUBLE SHOOTING

If the monitor fails to operate correctly, please follow the steps below for a possible solution.

1. Perform the adjustments described in OPERATING THE MONITOR, depending on the problem you have. If the monitor does not get a picture, skip to 2.
2. Consult the following items if you cannot find an appropriate adjustment item in OPERATING THE MONITOR or if the problem persists.
3. If you are experiencing a problem which is not described below or you cannot correct the problem, discontinue using the monitor and contact your dealer or iiyama service center for further assistance.

Problem	Check
① The picture does not appear. (Power indicator does not light up.) (Power indicator is green.) (Power indicator is red.)	<input type="checkbox"/> The Power Cable is firmly seated in the socket. <input type="checkbox"/> The Power Switch is turned ON. <input type="checkbox"/> The AC socket is live. Please check with another piece of equipment. <input type="checkbox"/> If the blank screen saver is in active mode, touch the keyboard or the mouse. <input type="checkbox"/> Increase the Contrast and/or Brightness. <input type="checkbox"/> The computer is ON. <input type="checkbox"/> The Signal Cable is properly connected. <input type="checkbox"/> The signal timing of the computer is within the specification of the monitor. <input type="checkbox"/> If the monitor is in standby mode, touch the keyboard or the mouse. <input type="checkbox"/> The computer is ON. <input type="checkbox"/> The Signal Cable is properly connected. <input type="checkbox"/> The signal timing of the computer is within the specification of the monitor.
② The screen is not synchronized.	<input type="checkbox"/> The Signal Cable is properly connected. <input type="checkbox"/> The signal timing of the computer is within the specification of the monitor.
③ The screen position is not in the center.	<input type="checkbox"/> The signal timing of the computer is within the specification of the monitor.
④ The screen is too bright or too dark.	<input type="checkbox"/> The video output level of the computer is within the specification of the monitor.
⑤ The screen is shaking.	<input type="checkbox"/> The power voltage is within the specification of the monitor. <input type="checkbox"/> The signal timing of the computer is within the specification of the monitor.
⑥ No sound.	<input type="checkbox"/> The audio equipment (computer etc.) is ON. <input type="checkbox"/> The Audio Cable is properly connected. <input type="checkbox"/> The Volume is turned up. <input type="checkbox"/> The Mute is OFF. <input type="checkbox"/> The audio output level of the audio equipment is within the specification of the monitor.
⑦ The sound is too loud or too quiet.	<input type="checkbox"/> The audio output level of the audio equipment is within the specification of the monitor.
⑧ A strange noise is heard.	<input type="checkbox"/> The Audio Cable is properly connected.

RECYCLING INFORMATION

For better environment protection please don't dispose your monitor.
Please visit our web site: <https://iiyama.com> for monitor recycling.

APPENDIX

Design and specifications are subject to change without prior notice.

SPECIFICATIONS : ProLite LH3254HS-B1AG

Size Category	32"	
LCD Panel	Panel technology	IPS (In-Plane-Switching)
	Size	Diagonal: 31.5" (80cm)
	Pixel pitch	0.12125mm H × 0.36375mm V
	Brightness	500cd/m ² (Typical), 335cd/m ² (Default / Energy Saving)
	Contrast ratio	1200 : 1 (Typical)
	Viewable angle	Horizontal : 89 degrees, Vertical: 89 degrees (Typical)
	Response time	8ms (Typical, Gray to Gray)
Display Colors	8bit (Approx.16.7M)	
Sync Frequency	Horizontal: 28.0-160.0kHz, Vertical: 23-85Hz	
Native Resolution	1920 × 1080, 2.1 MegaPixels	
Support Max. Resolution	DVI: 1920 × 1080 60Hz HDMI/DisplayPort: 1920 × 1080 60Hz	
Input Connector	DVI-I, HDMI × 3, DisplayPort	
Input Audio Connector	ø 3.5mm mini jack (Stereo)	
LAN	RJ45	
Serial Port	RS-232C In/Out ø 2.5mm sub-mini jack	
Input Video Signal	Digital: DVI (Digital Visual Interface Standard Rev.1.0) compliance Digital: HDMI, DisplayPort	
Input Audio Signal	0.5Vrms maximum	
IR Extender Connector	IR In/Out	
USB Connector	USB2.0(DC5V, 500mA) (USB Media Player) × 2	
Micro SD card slot	Micro SD	
Output Connector	DisplayPort	
Headphone Connector	ø 3.5mm mini jack (Stereo)	
Speakers	Internal: 10W×2 (Stereo speakers)	
Maximum Screen Size	698.40mm W × 392.85mm H / 27.5" W × 15.5" H	
Power Source	100-240VAC, 50-60Hz, 2.0A	
Power Consumption*	67W typical, Standby mode: 0.5W maximum, Off mode: 0.3W maximum	
Dimensions / Net Weight	733.0 × 427.5 × 66.5mm / 28.9 × 16.8 × 2.6" (W×H×D) 5.4kg / 11.9lbs	
Environmental Considerations	Operating:	Temperature 0 to 40°C / 32 to 104°F Humidity 20 to 80% (No condensation)
	Storage:	Temperature -20 to 60°C / 4 to 140°F Humidity 10 to 90% (No condensation)
Approvals	CE, UKCA, EAC, TÜV-Bauart	

NOTE * When the USB devices are not connected.

SPECIFICATIONS : ProLite LH4354UHS-B1AG

Size Category		43"
LCD Panel	Panel technology	IPS (In-Plane-Switching)
	Size	Diagonal: 42.5" (108cm)
	Pixel pitch	0.0871mm H × 0.2451mm V
	Brightness	500cd/m ² (Typical), 335cd/m ² (Default / Energy Saving)
	Contrast ratio	1200 : 1 (Typical)
	Viewable angle	Horizontal : 89 degrees, Vertical: 89 degrees (Typical)
	Response time	8ms (Typical, Gray to Gray)
Display Colors		Approx. 1.07G
Sync Frequency		Horizontal: 28.0-160.0kHz, Vertical: 23-85Hz
Native Resolution		3840 × 2160, 8.3 MegaPixels
Support Max. Resolution		DVI: 1920 × 1080 60Hz HDMI/DisplayPort: 3840 × 2160 60Hz
Input Connector		DVI-I, HDMI × 3, DisplayPort
Input Audio Connector		ø 3.5mm mini jack (Stereo)
LAN		RJ45
Serial Port		RS-232C In/Out ø 2.5mm sub-mini jack
Input Video Signal		Digital: DVI (Digital Visual Interface Standard Rev.1.0) compliance Digital: HDMI, DisplayPort
Input Audio Signal		0.5Vrms maximum
IR Extender Connector		IR In/Out
USB Connector		USB2.0(DC5V, 500mA) (USB Media Player) × 2
Micro SD card slot		Micro SD
Output Connector		DisplayPort
Headphone Connector		ø 3.5mm mini jack (Stereo)
Speakers		Internal: 10W×2 (Stereo speakers)
Maximum Screen Size		941.184mm W × 529.416mm H / 37.1" W × 20.8" H
Power Source		100-240VAC, 50-60Hz, 2.5A
Power Consumption*		124W typical, Standby mode: 0.5W maximum, Off mode: 0.3W maximum
Dimensions / Net Weight		972.0 × 560.0 × 67.5mm / 38.3 × 22.0 × 2.7" (W×H×D) 9.1kg / 20.1lbs
Environmental Considerations		Operating: Temperature 0 to 40°C / 32 to 104°F Humidity 20 to 80% (No condensation) Storage: Temperature -20 to 60°C / 4 to 140°F Humidity 10 to 90% (No condensation)
Approvals		CE, UKCA, EAC, TÜV-Bauart

NOTE * When the USB devices are not connected.

SPECIFICATIONS : ProLite LH5054UHS-B1AG

Size Category	50"	
LCD Panel	Panel technology	VA
	Size	Diagonal: 50" (127cm)
	Pixel pitch	0.285375mm H × 0.285375mm V
	Brightness	500cd/m ² (Typical), 310cd/m ² (Default / Energy Saving)
	Contrast ratio	5000 : 1 (Typical)
	Viewable angle	Horizontal : 89 degrees, Vertical: 89 degrees (Typical)
	Response time	9.5ms (Typical, Gray to Gray)
Display Colors	Approx.1.07G	
Sync Frequency	Horizontal: 28.0-160.0kHz, Vertical: 23-85Hz	
Native Resolution	3840 × 2160, 8.3 MegaPixels	
Support Max. Resolution	DVI: 1920 × 1080 60Hz HDMI/DisplayPort: 3840 × 2160 60Hz	
Input Connector	DVI-I, HDMI × 3, DisplayPort	
Input Audio Connector	ø 3.5mm mini jack (Stereo)	
LAN	RJ45	
Serial Port	RS-232C In/Out ø 2.5mm sub-mini jack	
Input Video Signal	Digital: DVI (Digital Visual Interface Standard Rev.1.0) compliance Digital: HDMI, DisplayPort	
Input Audio Signal	0.5Vrms maximum	
IR Extender Connector	IR In/Out	
USB Connector	USB2.0(DC5V, 500mA) (USB Media Player) × 2	
Micro SD card slot	Micro SD	
Output Connector	DisplayPort	
Headphone Connector	ø 3.5mm mini jack (Stereo)	
Speakers	Internal: 10W×2 (Stereo speakers)	
Maximum Screen Size	1095.84mm W × 616.41mm H / 43.1" W × 24.3" H	
Power Source	100-240VAC, 50-60Hz, 3.0A	
Power Consumption*	156W typical, Standby mode: 0.5W maximum, Off mode: 0.3W maximum	
Dimensions / Net Weight	1127.5 × 648.0 × 72.5mm / 44.4 × 25.5 × 2.9" (W×H×D) 13.6kg / 30.0lbs	
Environmental Considerations	Operating: Temperature 0 to 40°C / 32 to 104°F Humidity 20 to 80% (No condensation) Storage: Temperature -20 to 60°C / 4 to 140°F Humidity 10 to 90% (No condensation)	
Approvals	CE, UKCA, EAC, TÜV-Bauart	

NOTE * When the USB devices are not connected.

SPECIFICATIONS : ProLite LH5554UHS-B1AG

Size Category		55"
LCD Panel	Panel technology	IPS (In-Plane-Switching)
	Size	Diagonal: 54.6" (139cm)
	Pixel pitch	0.315mm H × 0.315mm V
	Brightness	500cd/m ² (Typical), 335cd/m ² (Default / Energy Saving)
	Contrast ratio	1200 : 1 (Typical)
	Viewable angle	Horizontal : 89 degrees, Vertical: 89 degrees (Typical)
	Response time	8ms (Typical, Gray to Gray)
Display Colors		Approx. 1.07G
Sync Frequency		Horizontal: 28.0-160.0kHz, Vertical: 23-85Hz
Native Resolution		3840 × 2160, 8.3 MegaPixels
Support Max. Resolution		DVI: 1920 × 1080 60Hz HDMI/DisplayPort: 3840 × 2160 60Hz
Input Connector		DVI-I, HDMI × 3, DisplayPort
Input Audio Connector		ø 3.5mm mini jack (Stereo)
LAN		RJ45
Serial Port		RS-232C In/Out ø 2.5mm sub-mini jack
Input Video Signal		Digital: DVI (Digital Visual Interface Standard Rev.1.0) compliance Digital: HDMI, DisplayPort
Input Audio Signal		0.5Vrms maximum
IR Extender Connector		IR In/Out
USB Connector		USB2.0(DC5V, 500mA) (USB Media Player) × 2
Micro SD card slot		Micro SD
Output Connector		DisplayPort
Headphone Connector		ø 3.5mm mini jack (Stereo)
Speakers		Internal: 10W×2 (Stereo speakers)
Maximum Screen Size		1209.6mm W × 680.4mm H / 47.6" W × 26.8" H
Power Source		100-240VAC, 50-60Hz, 3.0A
Power Consumption*		151W typical, Standby mode: 0.5W maximum, Off mode: 0.3W maximum
Dimensions / Net Weight		1240.5 × 711.5 × 69.0mm / 48.8 × 28.0 × 2.7" (W×H×D) 15.0kg / 33.1lbs
Environmental Considerations		Operating: Temperature 0 to 40°C / 32 to 104°F Humidity 20 to 80% (No condensation) Storage: Temperature -20 to 60°C / 4 to 140°F Humidity 10 to 90% (No condensation)
Approvals		CE, UKCA, EAC, TÜV-Bauart

NOTE * When the USB devices are not connected.

SPECIFICATIONS : ProLite LH6554UHS-B1AG

Size Category	65"	
LCD Panel	Panel technology	IPS (In-Plane-Switching)
	Size	Diagonal: 64.5" (164cm)
	Pixel pitch	0.372mm H × 0.372mm V
	Brightness	500cd/m ² (Typical), 310cd/m ² (Default / Energy Saving)
	Contrast ratio	1200 : 1 (Typical)
	Viewable angle	Horizontal : 89 degrees, Vertical: 89 degrees (Typical)
	Response time	8ms (Typical, Gray to Gray)
Display Colors	Approx.1.07G	
Sync Frequency	Horizontal: 28.0-160.0kHz, Vertical: 23-85Hz	
Native Resolution	3840 × 2160, 8.3 MegaPixels	
Support Max. Resolution	DVI: 1920 × 1080 60Hz HDMI/DisplayPort: 3840 × 2160 60Hz	
Input Connector	DVI-I, HDMI × 3, DisplayPort	
Input Audio Connector	ø 3.5mm mini jack (Stereo)	
LAN	RJ45	
Serial Port	RS-232C In/Out ø 2.5mm sub-mini jack	
Input Video Signal	Digital: DVI (Digital Visual Interface Standard Rev.1.0) compliance Digital: HDMI, DisplayPort	
Input Audio Signal	0.5Vrms maximum	
IR Extender Connector	IR In/Out	
USB Connector	USB2.0(DC5V, 500mA) (USB Media Player) × 2	
Micro SD card slot	Micro SD	
Output Connector	DisplayPort	
Headphone Connector	ø 3.5mm mini jack (Stereo)	
Speakers	Internal: 10W×2 (Stereo speakers)	
Maximum Screen Size	1428.48mm W × 803.52mm H / 56.2" W × 31.6" H	
Power Source	100-240VAC, 50-60Hz, 4.0A	
Power Consumption*	191W typical, Standby mode: 0.5W maximum, Off mode: 0.3W maximum	
Dimensions / Net Weight	1463.0 × 838.0 × 73.0mm / 57.6 × 33.0 × 2.9" (W×H×D) 22.3kg / 49.2lbs	
Environmental Considerations	Operating: Temperature 0 to 40°C / 32 to 104°F Humidity 20 to 80% (No condensation) Storage: Temperature -20 to 60°C / 4 to 140°F Humidity 10 to 90% (No condensation)	
Approvals	CE, UKCA, EAC, TÜV-Bauart	

NOTE * When the USB devices are not connected.

SPECIFICATIONS : ProLite LH7554UHS-B1AG

Size Category		75"
LCD Panel	Panel technology	IPS (In-Plane-Switching)
	Size	Diagonal: 74.5" (189cm)
	Pixel pitch	0.4296mm H × 0.4296mm V
	Brightness	500cd/m ² (Typical), 335cd/m ² (Default / Energy Saving)
	Contrast ratio	1200 : 1 (Typical)
	Viewable angle	Horizontal : 89 degrees, Vertical: 89 degrees (Typical)
	Response time	8ms (Typical, Gray to Gray)
Display Colors		Approx. 1.07G
Sync Frequency		Horizontal: 28.0-160.0kHz, Vertical: 23-85Hz
Native Resolution		3840 × 2160, 8.3 MegaPixels
Support Max. Resolution		DVI: 1920 × 1080 60Hz HDMI/DisplayPort: 3840 × 2160 60Hz
Input Connector		DVI-I, HDMI × 3, DisplayPort
Input Audio Connector		ø 3.5mm mini jack (Stereo)
LAN		RJ45
Serial Port		RS-232C In/Out ø 2.5mm sub-mini jack
Input Video Signal		Digital: DVI (Digital Visual Interface Standard Rev.1.0) compliance Digital: HDMI, DisplayPort
Input Audio Signal		0.5Vrms maximum
IR Extender Connector		IR In/Out
USB Connector		USB2.0(DC5V, 500mA) (USB Media Player) × 2
Micro SD card slot		Micro SD
Output Connector		DisplayPort
Headphone Connector		ø 3.5mm mini jack (Stereo)
Speakers		Internal: 10W×2 (Stereo speakers)
Maximum Screen Size		1649.664mm W × 927.936mm H / 64.9" W × 36.5" H
Power Source		100-240VAC, 50-60Hz, 4.0A
Power Consumption*		236W typical, Standby mode: 0.5W maximum, Off mode: 0.3W maximum
Dimensions / Net Weight		1683.5 × 961.5 × 85.0mm / 66.3 × 37.9 × 3.3" (W×H×D) 29.6kg / 65.3lbs
Environmental Considerations		Operating: Temperature 0 to 40°C / 32 to 104°F Humidity 20 to 80% (No condensation) Storage: Temperature -20 to 60°C / 4 to 140°F Humidity 10 to 90% (No condensation)
Approvals		CE, UKCA, EAC, TÜV-Bauart

NOTE * When the USB devices are not connected.

SPECIFICATIONS : ProLite LH8654UHS-B1AG

Size Category	86"	
LCD Panel	Panel technology	IPS (In-Plane-Switching)
	Size	Diagonal: 85.6" (217cm)
	Pixel pitch	0.4935mm H × 0.4935mm V
	Brightness	500cd/m ² (Typical), 315cd/m ² (Default / Energy Saving)
	Contrast ratio	1400 : 1 (Typical)
	Viewable angle	Horizontal : 89 degrees, Vertical: 89 degrees (Typical)
	Response time	8ms (Typical, Gray to Gray)
Display Colors	Approx.1.07G	
Sync Frequency	Horizontal: 28.0-160.0kHz, Vertical: 23-85Hz	
Native Resolution	3840 × 2160, 8.3 MegaPixels	
Support Max. Resolution	DVI: 1920 × 1080 60Hz HDMI/DisplayPort: 3840 × 2160 60Hz	
Input Connector	DVI-I, HDMI × 3, DisplayPort	
Input Audio Connector	ø 3.5mm mini jack (Stereo)	
LAN	RJ45	
Serial Port	RS-232C In/Out ø 2.5mm sub-mini jack	
Input Video Signal	Digital: DVI (Digital Visual Interface Standard Rev.1.0) compliance Digital: HDMI, DisplayPort	
Input Audio Signal	0.5Vrms maximum	
IR Extender Connector	IR In/Out	
USB Connector	USB2.0(DC5V, 500mA) (USB Media Player) × 2	
Micro SD card slot	Micro SD	
Output Connector	DisplayPort	
Headphone Connector	ø 3.5mm mini jack (Stereo)	
Speakers	Internal: 10W×2 (Stereo speakers)	
Maximum Screen Size	1895.04mm W × 1065.96mm H / 74.6" W × 42.0" H	
Power Source	100-240VAC, 50-60Hz, 6.5A	
Power Consumption*	349W typical, Standby mode: 0.5W maximum, Off mode: 0.3W maximum	
Dimensions / Net Weight	1933.0 × 1103.0 × 86.0mm / 76.1 × 43.4 × 3.4" (W×H×D) 55.2kg / 121.7lbs	
Environmental Considerations	Operating: Temperature 0 to 40°C / 32 to 104°F Humidity 20 to 80% (No condensation) Storage: Temperature -20 to 60°C / 4 to 140°F Humidity 10 to 90% (No condensation)	
Approvals	CE, UKCA, EAC, TÜV-Bauart	

NOTE * When the USB devices are not connected.

DIMENSIONS : ProLite LH3254HS

ENGLISH

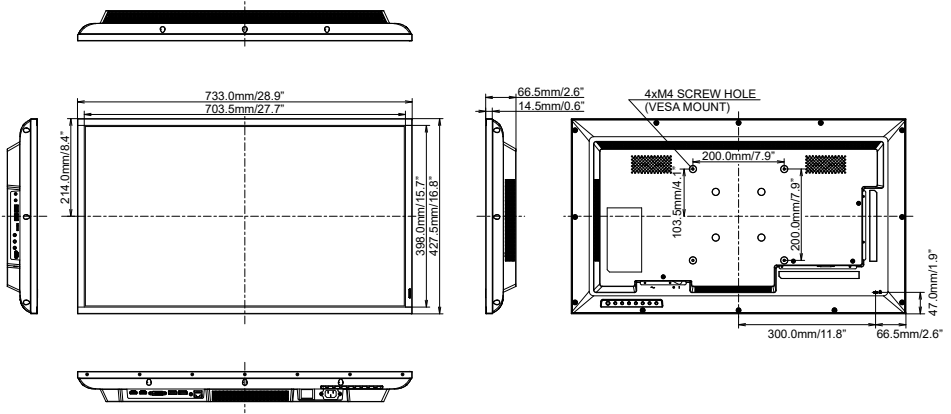

DIMENSIONS : ProLite LH4354UHS

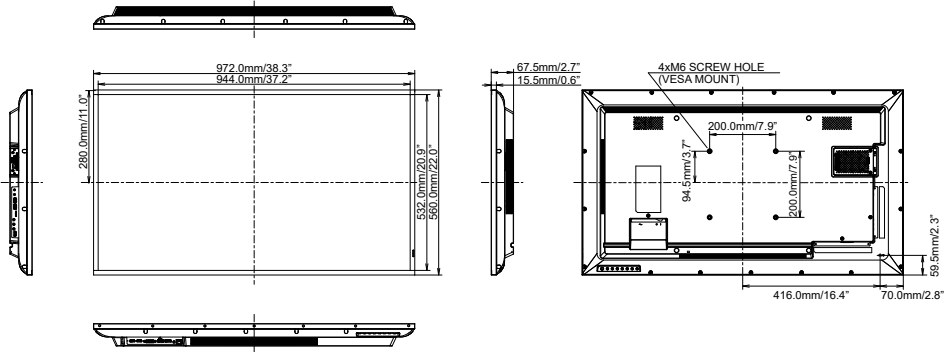

DIMENSIONS : ProLite LH5054UHS

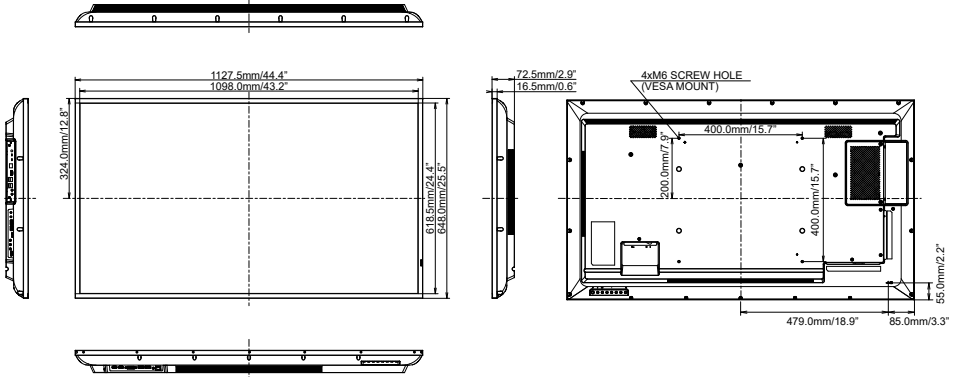

DIMENSIONS : ProLite LH5554UHS

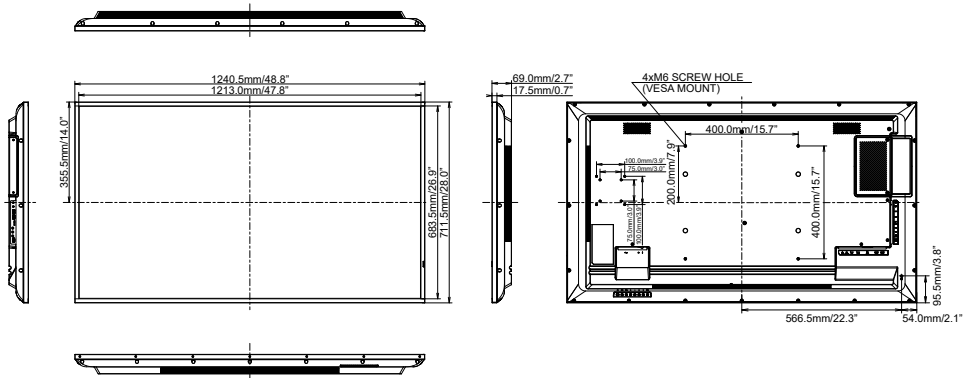

DIMENSIONS : ProLite LH8654UHS

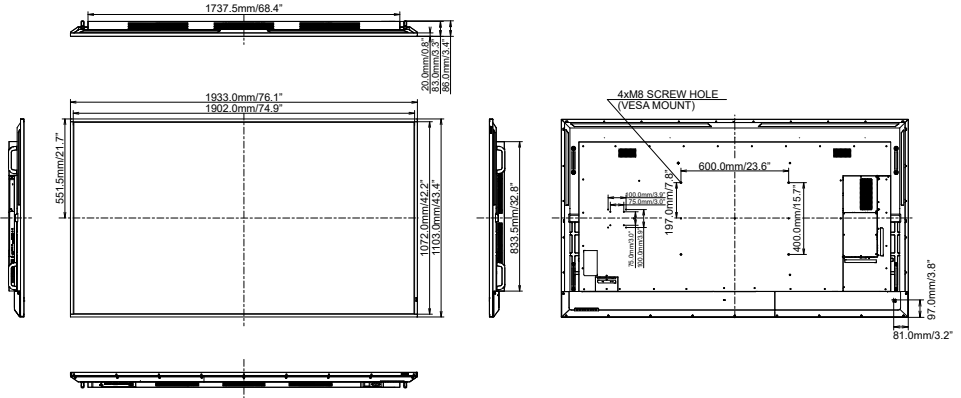

ENGLISH

COMPLIANT TIMING

Timing		fH (kHz)	fV (Hz)	Dot clock (MHz)	VGA (via DVI)	DVI	HDMI1	HDMI2	HDMI3	DisplayPort
VESA	VGA 640x480	31.5	60.0	25.175	○	○	○	○	○	○
	SVGA 800x600	37.9	60.0	40.000	○	○	○	○	○	○
	XGA 1024x768	48.4	60.0	65.000	○	○	○	○	○	○
	QVGA 1280x960	64.0	60.0	108.000	○	○	○	○	○	○
	SXGA 1280x1024	64.0	60.0	108.000	○	○	○	○	○	○
	WXGA 1366x768	47.7	60.0	85.500	○	○	○	○	○	○
	CVT 1440x900	55.9	60.0	106.500	○	○	○	○	○	○
	UXGA 1680x1050	65.3	60.0	146.250	○	○	○	○	○	○
	FHD 1920x1080	67.5	60.0	148.500	○	○	○	○	○	○
	2048x1152 *2	70.9	60.0	156.750						
	2560x1080 *2	66.0	60.0	198.000						
	2560x1440 *2	88.8	60.0	241.700		○				
	2560x1600 *2	98.7	60.0	268.500						
	3200x1800 *2	111.1	60.0	391.140						
4K 3840x2160 *2		67.5	30.0	297.000						
		135.0	60.0	594.000						
IBM	720x400	31.5	70.0	28.320	○					
SD	480i	60Hz	15.7	60.0	27.000	○	○	○	○	○
	576i	50Hz	15.6	50.0	13.500	○	○	○	○	○
	480p	60Hz	31.5	60.0	27.000	○	○	○	○	○
	576p	50Hz	31.3	50.0	27.000	○	○	○	○	○
HD	720p	50Hz	37.5	50.0	27.000	○	○	○	○	○
		60Hz	45.0	60.0	74.250	○	○	○	○	○
	1080i	50Hz	28.1	50.0	74.250	○	○	○	○	○
		60Hz	33.7	60.0	74.250	○	○	○	○	○
	1080p	50Hz	56.3	50.0	148.500	○	○	○	○	○
		60Hz	67.5	60.0	148.500	○	○	○	○	○

*1 ○ means supported the timing.

*2 Not available for ProLite LH3254HS