

USER MANUAL

ProLite

LCD Monitor

ENGLISH

ProLite XUB2494HSU

ProLite XU2494HSU

ProLite XUB2494HS

ProLite XU2494HS

ProLite XUB2794HSU

ProLite XU2794HSU

Thank you very much for choosing the iiyama LCD monitor.

We recommend that you take a few minutes to read this comprehensive manual carefully before installing and switching on the monitor. Please keep this manual in a safe place for your future reference.

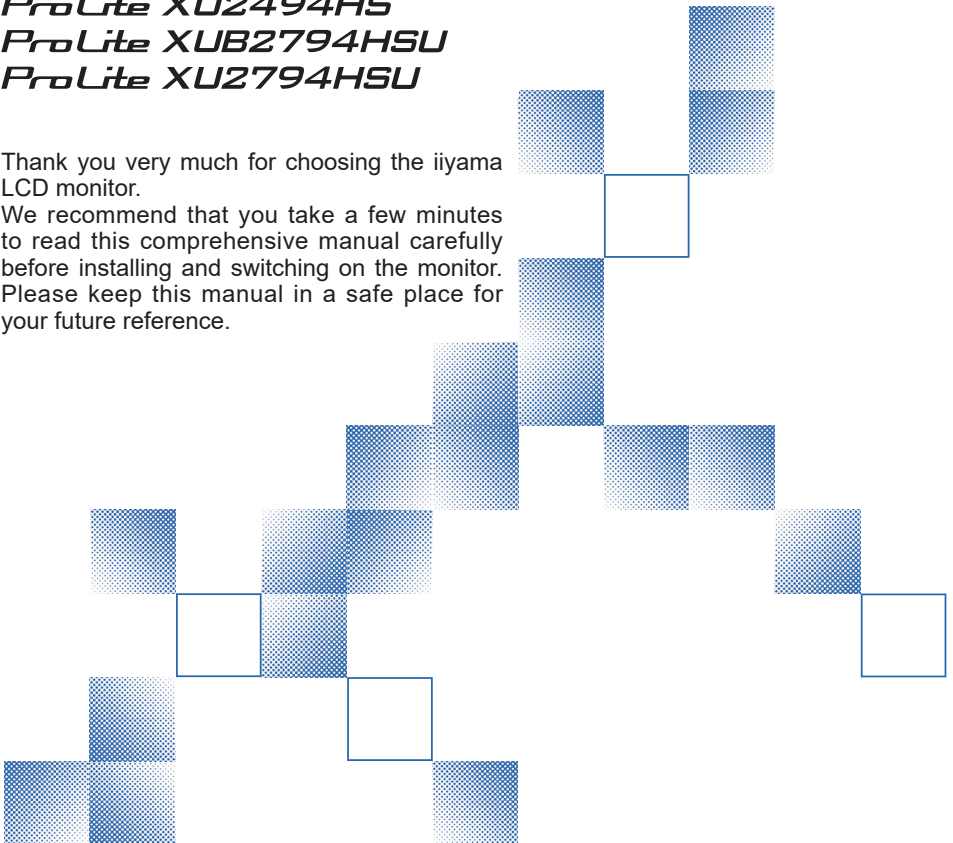



Dear user, we congratulate you on the purchase of your iiyama LCD.

For details on warranty and locally used pixel policies that apply directly after installation of your product please check the iiyama website.

To report a fault, please contact your local support centre found at <https://iiyama.com>

Things to check before you call the iiyama information line

- | if the power cable is connected securely and turned on?
- | if the display has been turned on?
- | if the signal cable is connected securely and the correct input selected?
- | if the computer has been restarted with the display connected?
- | if the graphics card is correctly installed with the latest drivers possible?
- | if the correct native resolution has been selected via 'Display Properties'?
- | If the R/G/B signal configuration is correct?
- | if the displays On Screen Menu is shown?
- | if the correct brightness and contrast settings have been set?
- | if given display tolerances and compatibility have been considered?
- | if via the On Screen Menu you have performed a Factory Reset/Recall?



Before reporting the screen defect, please prepare the following information/evidence:

- | model number *
- | purchase receipt and serial number *
- | name and address for collection
- | telephone/fax number, for availability during the day
- | convenient collection date (date, time)
- | short description of the defect

Important Note:

If there is no fault found in the collected equipment after inspection, the transferring party shall incur charges for transport and administration.

If you have checked all of the above and there is still no picture, call our information line for assistance in your country.

* see the identification plate on the back of the case.

CE MARKING DECLARATION OF CONFORMITY

This LCD monitor complies with the requirements of the EC/EU Directive 2014/30/EU "EMC Directive", 2014/35/EU "Low Voltage Directive", 2009/125/EC "ErP Directive" and 2011/65/EU "RoHS Directive".

The electro-magnetic susceptibility has been chosen at a level that gives correct operation in residential areas, business and light industrial premises and small-scale enterprises, inside as well as outside of the buildings. All places of operation are characterised by their connection to the public low voltage power supply system.

IYAMA CORPORATION: Wijkmeerstraat 8, 2131 HA Hoofddorp, The Netherlands

Model No. : PL2494H, PL2794H



We recommend recycling of used product. Please contact your dealer or iiyama service center. Recycle information is obtained via the Internet, using the address: <https://iiyama.com>
You can access the Web page of different countries from there.

- We reserve the right to change specifications without notice.
- All trademarks used in this user manual are the property of their respective owners.
- The terms HDMI and HDMI High-Definition Multimedia Interface, and the HDMI Logo are trademarks or registered trademarks of HDMI Licensing Administrator, Inc. in the United States and other countries.
- The font used in the OSD menu is licensed under the Apache License, Version 2.0. You may obtain a copy of the License at <http://www.apache.org/licenses/LICENSE-2.0>
- Eprel registration number
 - XUB2494HSU-B2 : 1320586 XUB2494HS-B2 : 1320627
 - XUB2494HSU-B2 A : 1551895 XUB2494HS-B2 A : 1551910
 - XUB2794HSU-B1 : 1330085
 - XUB2794HSU-B1 A : 1552059
 - XU2494HSU-B2 : 1320605 XU2494HS-B2 : 1320664
 - XU2794HSU-B1 : 1330131

TABLE OF CONTENTS

FOR YOUR SAFETY.....	1
SAFETY PRECAUTIONS.....	1
SPECIAL NOTES ON LCD MONITORS.....	3
CUSTOMER SERVICE.....	3
CLEANING.....	3
BEFORE YOU OPERATE THE MONITOR.....	4
FEATURES.....	4
CHECKING THE CONTENTS OF THE PACKAGE.....	4
USING ARM OR STAND.....	5
FITTING AND REMOVAL OF STAND :	
ProLite XUB2494HS(U), XUB2794HSU.....	7
FITTING AND REMOVAL OF STAND :	
ProLite XU2494HS(U), XU2794HSU.....	9
CONTROLS AND CONNECTORS :	
ProLite XUB2494HS(U), XUB2794HSU.....	10
CONTROLS AND CONNECTORS :	
ProLite XU2494HS(U), XU2794HSU.....	11
CONNECTING YOUR MONITOR :	
ProLite XUB2494HS(U), XUB2794HSU.....	12
CONNECTING YOUR MONITOR :	
ProLite XU2494HS(U), XU2794HSU.....	13
COMPUTER SETTING.....	14
ADJUSTING THE HEIGHT AND THE VIEWING ANGLE :	
ProLite XUB2494HS(U), XUB2794HSU.....	14
ADJUSTING THE VIEWING ANGLE :	
ProLite XU2494HS(U), XU2794HSU.....	15
OPERATING THE MONITOR.....	16
JOYSTICK.....	16
ADJUSTMENT MENU CONTENTS.....	18
STANDBY FEATURE.....	26
TROUBLE SHOOTING.....	27
RECYCLING INFORMATION.....	28
APPENDIX.....	29
SPECIFICATIONS :	
ProLite XUB2494HSU-B2 / ProLite XUB2494HS-B2.....	29
SPECIFICATIONS :	
ProLite XUB2494HSU-B2 A / ProLite XUB2494HS-B2 A.....	30
SPECIFICATIONS :	
ProLite XU2494HSU-B2 / ProLite XU2494HS-B2.....	31
SPECIFICATIONS :	
ProLite XUB2794HSU-B1 / ProLite XUB2794HSU-B1 A.....	32
SPECIFICATIONS : ProLite XU2794HSU-B1.....	33
DIMENSIONS : ProLite XUB2494HS(U).....	34
DIMENSIONS : ProLite XU2494HS(U).....	34
DIMENSIONS : ProLite XUB2794HSU.....	35
DIMENSIONS : ProLite XU2794HSU.....	35
COMPLIANT TIMING.....	36

FOR YOUR SAFETY

SAFETY PRECAUTIONS

WARNING

STOP OPERATING THE MONITOR WHEN YOU SENSE TROUBLE

If you notice any abnormal phenomena such as smoke, strange sounds or fumes, unplug the monitor and contact your dealer or iiyama service center immediately. Further use may be dangerous and can cause fire or electric shock.

NEVER REMOVE THE CABINET

High voltage circuits are inside the monitor. Removing the cabinet may expose you to the danger of fire or electric shock.

DO NOT PUT ANY OBJECT INTO THE MONITOR

Do not put any solid objects or liquids such as water into the monitor. In case of an accident, unplug your monitor immediately and contact your dealer or iiyama service center. Using the monitor with any object inside may cause fire, electric shock or damage.

INSTALL THE MONITOR ON A FLAT, STABLE SURFACE

The monitor may cause an injury if it falls or is dropped.

DO NOT USE THE MONITOR NEAR WATER

Do not use where water may be splashed or spilt onto the monitor as it may cause fire or electric shock.

OPERATE UNDER THE SPECIFIED POWER SUPPLY

Be sure to operate the monitor only with the specified power supply. Use of an incorrect voltage will cause malfunction and may cause fire or electric shock.

PROTECT THE CABLES

Do not pull or bend the power cable and signal cable. Do not place the monitor or any other heavy objects on the cables. If damaged, the cables may cause fire or electric shock.

ADVERSE WEATHER CONDITIONS

It is advisable not to operate the monitor during a heavy thunder storm as the continual breaks in power may cause malfunction. It is also advised not to touch the plug in these circumstances as it may cause electric shock.

CAUTION

INSTALLATION LOCATION

Do not install the monitor where sudden temperature changes may occur, or in humid, dusty or smoky areas as it may cause fire, electric shock or damage. You should also avoid areas where the sun shines directly on the monitor.

DO NOT PLACE THE MONITOR IN A HAZARDOUS POSITION

The monitor may topple and cause injury if not suitably located. Please also ensure that you do not place any heavy objects on the monitor, and that all cables are routed such that children may not pull the cables and possibly cause injury.

MAINTAIN GOOD VENTILATION

Ventilation slots are provided to keep the monitor from overheating. Covering the slots may cause fire. To allow adequate air circulation, place the monitor at least 10cm (or 4 inches) from any walls.

When removing the tilt stand, the ventilation slots on the back side of the monitor can be blocked. This may overheat the monitor and may cause fire or damage. Make sure to allow enough ventilation when removing the tilt stand. Operating the monitor on its back, side, upside down or on a carpet or any other soft material may also cause damage.

DISCONNECT THE CABLES WHEN YOU MOVE THE MONITOR

When you move the monitor, turn off the Power Button, unplug the monitor and be sure the signal cable is disconnected. If you do not disconnect them, it may cause fire or electric shock.

UNPLUG THE MONITOR

If the monitor is not in use for a long period of time it is recommended that it is left unplugged to avoid accidents.

HOLD THE PLUG WHEN DISCONNECTING

To disconnect the power cable or signal cable, always pull it by the plug. Never pull on the cable itself as this may cause fire or electric shock.

DO NOT TOUCH THE PLUG WITH WET HANDS

Pulling or inserting the plug with wet hands may cause electric shock.

WHEN YOU INSTALL THE MONITOR ON YOUR COMPUTER

Be sure the computer is strong enough to hold the weight of the monitor, otherwise, you may damage your computer.

CAREFUL! PROTECT YOUR HANDS AND FINGERS

- Be careful not to hurt your fingers or hands when you change the height or the angle.
- Injury can occur if care is not taken to avoid finger contact with the displays base when adjusting the height. (Just for height adjustable model.)

REMARK FOR 24/7 USAGE

This product is not specifically designed for 24/7 usage in all environments.

REMARK FOR WALL MOUNTING

This product is not designed for digital signage (electronic signboard) applications such as wall mounting.

OTHERS

ERGONOMIC RECOMMENDATIONS

To eliminate eye fatigue, do not operate the monitor against a bright background or in a dark room. For optimal viewing comfort, the monitor should be just below eye level and 40-60cm (16-24 inches) away from your eyes. When using the monitor over a prolonged time, a ten minute break every hour is recommended as looking at the screen continuously can cause eye strain.

SPECIAL NOTES ON LCD MONITORS

The following symptoms are normal with LCD monitors and do not indicate a problem.

- NOTE**
- When you first turn on the LCD monitor, the picture may not fit in the display area because of the type of computer that is used. In this case, adjust the picture position to the correct position.
 - You may find slightly uneven brightness on the screen depending on the desktop pattern you use.
 - Due to the nature of the LCD screen, an afterimage of the previous screen may remain after switching the image, when the same image is displayed for hours. In this case, the screen can be recovered slowly by changing the image or turning off the Power Button for some hours.

CUSTOMER SERVICE

- NOTE**
- If you have to return your unit for service and the original packaging has been discarded, please contact your dealer or iiyama service center for advice or replacement packaging.

CLEANING

- WARNING**
- If you drop any materials or liquids such as water into the monitor when cleaning, unplug the power cable immediately and contact your dealer or iiyama service center.

- CAUTION**
- For safety reasons, turn off the Power Button and unplug the monitor before you clean it.

- NOTE**
- To protect the LCD panel, do not scratch or rub the screen with a hard object.
 - Never use any of the following strong solvents. These will damage the cabinet and the LCD screen.

Thinner	Spray-type cleaner
Benzine	Wax
Abrasive cleaner	Acid or Alkaline solvent

- Touching the cabinet with any product made from rubber or plastic for a long time may cause degeneration or loss of paint on the cabinet.

CABINET Stains can be removed with a cloth lightly moistened with a mild detergent solvent. Then wipe the cabinet with a soft dry cloth.

LCD SCREEN Periodic cleaning with a soft dry cloth is recommended.
Don't use tissue paper etc. because these will damage the LCD screen.

BEFORE YOU OPERATE THE MONITOR

FEATURES

- ◆ Supports Resolutions up to 1920 × 1080
- ◆ High Contrast 3000:1 (Typical), Adv. Contrast Function Available
Brightness 250cd/m² (Typical)
- ◆ Quick Response Time 4ms (Gray to Gray)
- ◆ Flicker - Free
- ◆ Blue Light Reducer
- ◆ Digital Character Smoothing
- ◆ 2 × 2W Stereo Speakers
- ◆ Standby Feature
- ◆ VESA Mounting Standard (100mm×100mm) Compliant
- ◆ Keyhole for Security Lock

CHECKING THE CONTENTS OF THE PACKAGE

The following accessories are included in your package. Check to see if they are enclosed with the monitor. If anything is missing or damaged, please contact your local iiyama dealer or regional iiyama office.

- | | | |
|------------------------------|---------------------|-------------------|
| ■ Power Cable *1 | ■ HDMI Cable | ■ USB Cable *2 |
| ■ VESA Plate *3 | ■ Screwdriver *3 | ■ Stand-Neck |
| ■ Stand-Base with a screw *3 | ■ Stand-Base *4 | ■ Cable Holder *4 |
| ■ Safety Guide | ■ Quick Start Guide | |

CAUTION

*1 The rating of the Power Cable enclosed in 120V area is 10A/125V. If you are using a power supply higher than this rating, then a power cable with a rating of 10A/250V must be used. However, all guarantees and warranties are void for any problems or damage caused by a power cable not supplied by iiyama.

An approved power cable greater or equal to H05VVVF, 3G, 0.75mm² must be used.

*2 Accessory for ProLite XU(B)2494HSU, XU(B)2794HSU

*3 Accessory for ProLite XUB2494HS(U), XUB2794HSU

*4 Accessory for ProLite XU2494HS(U), XU2794HSU

USING ARM OR STAND

CAUTION

- Before installation, make sure the display arm or desk arm stand is strong enough to hold the necessary weight of the monitor and the mount.
- Panel angle adjustment range : 23° upward and 5° downward

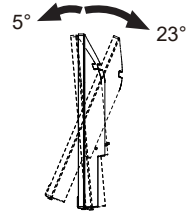

< DISPLAY ARM OR DESK ARM STAND >

WARNING

- When you use with the display arm or desk arm stand, in consideration of thickness of the mounting stage, tighten the M4 Screws (4pcs) which "L" length is 8.6mm to fasten the monitor. Using the screw longer than this may cause electric shock or damage because it may contact with the electrical parts inside the monitor.

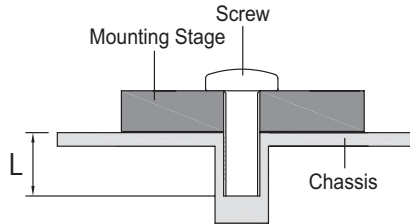

< ROTATING THE MONITOR >

● ProLite XUB2494HS(U), XUB2794HSU

The monitor is designed to be compatible with both landscape and portrait modes.
Video card for portrait display will be required for rotating the image on the screen.

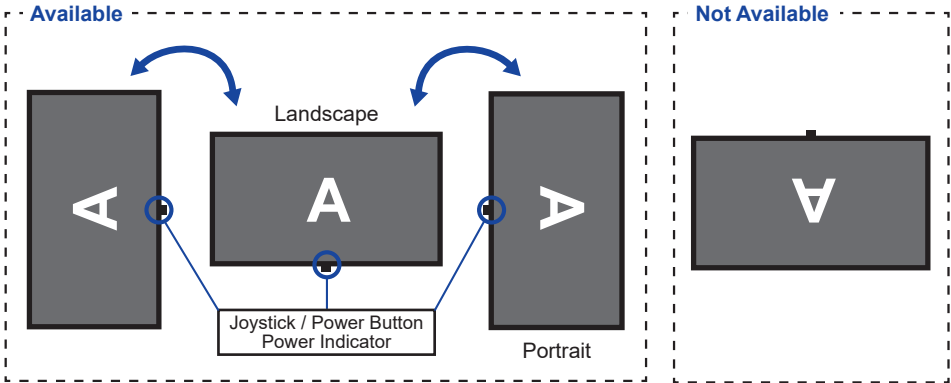

With Stand:

NOTE

- Adjust the monitor's height before panel rotation.
- Attempting to rotate the panel forcibly without adjusting the stand height may cause damage to the panel or the stand.

● ProLite XU2494HS(U), XU2794HSU

This monitor can only be used in landscape.

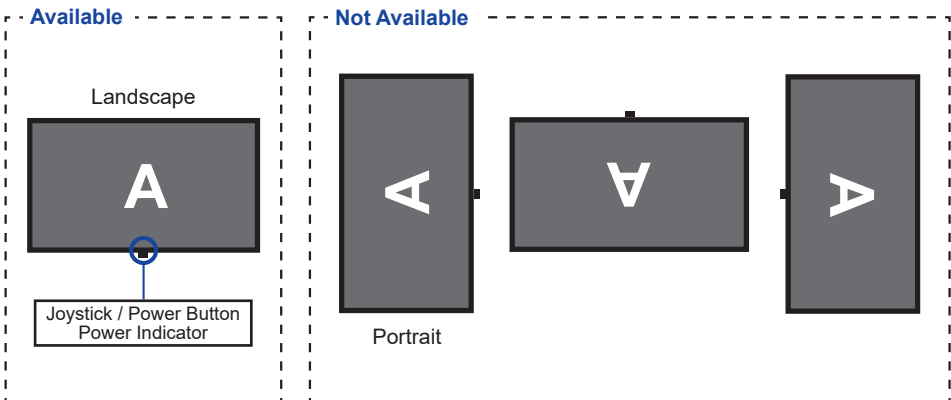

FITTING AND REMOVAL OF STAND : ProLite XUB2494HS(U), XUB2794HSU

CAUTION

- Put the monitor on a stable surface. The monitor may cause injury or damage if it falls or is dropped.
- Do not give a strong impact to the monitor. It may cause damage.
- Unplug the monitor before removal or installation to avoid an electric shock or a damage.

<Installation>

- ① Attach the Stand-Neck to the VESA Plate and then tighten the 'thumb screw' with the provided screwdriver to secure them.

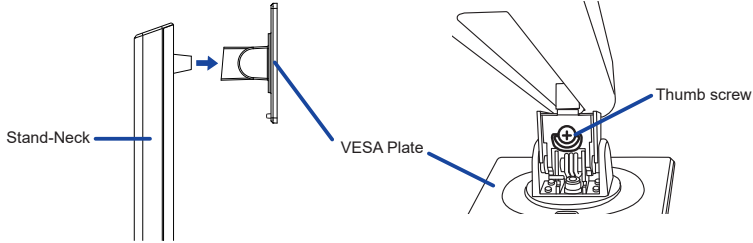

- ② Install the Stand-Base to the Stand-Neck and then tighten the 'thumb screw' with the provided screwdriver to secure them.

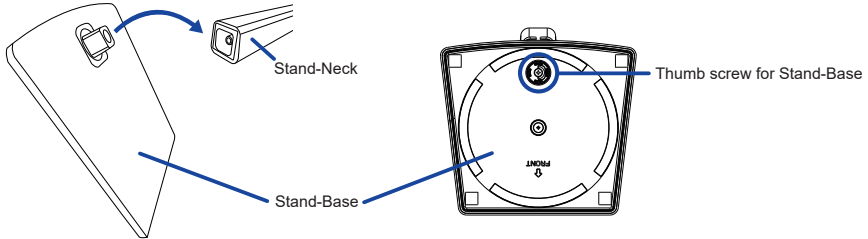

- ③ Put a piece of soft cloth on the table beforehand to prevent the monitor from being scratched. Lay the monitor flat on a table with front face down.
- ④ Hold the monitor and install the assembled stand to the monitor until it clicks to secure.

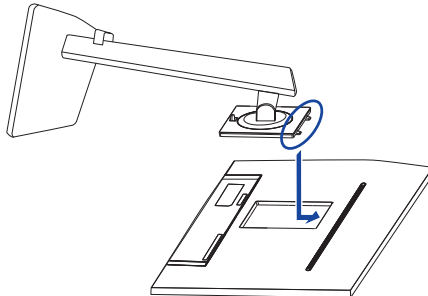

<Removal>

- ① Put a piece of soft cloth on the table beforehand to prevent the monitor from being scratched. Lay the monitor flat on a table with front face down.
- ② Press the release button to remove the stand.

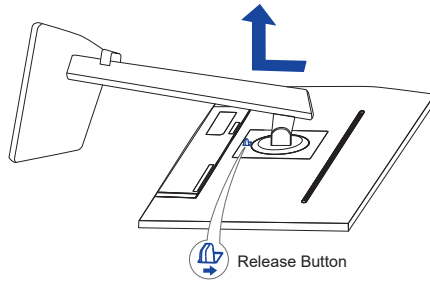

- ③ Loosen the 'thumb screw' with the provided screwdriver to remove the Stand-Neck from the VESA Plate.
- ④ Loosen the 'thumb screw' with the provided screwdriver to remove the Stand-Base from the Stand-Neck.

FITTING AND REMOVAL OF STAND : ProLite XU2494HS(U), XU2794HSU

CAUTION

- Put the monitor on a stable surface. The monitor may cause injury or damage if it falls or is dropped.
- Do not give a strong impact to the monitor. It may cause damage.
- Unplug the monitor before removal or installation to avoid an electric shock or a damage.

<Installation>

- ① Put a piece of soft cloth on the table beforehand to prevent the monitor from being scratched. Lay the monitor flat on a table with front face down.
- ② Hold the monitor and install the Stand-Neck to the monitor until it clicks to secure.
- ③ Install the Stand-Base to the Stand-Neck.
- ④ Place the Cable Holder.

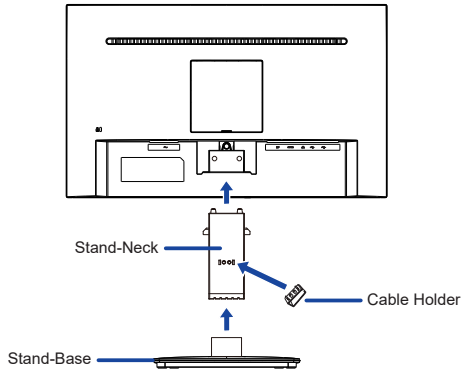

<Removal>

- ① Put a piece of soft cloth on the table beforehand to prevent the monitor from being scratched. Lay the monitor flat on a table with front face down.
- ② Keep pressing the Hooks inward to pull out the Stand-Base.
- ③ Press the release button and remove the Stand-Neck from the monitor.
- ④ Remove the Cable Holder.

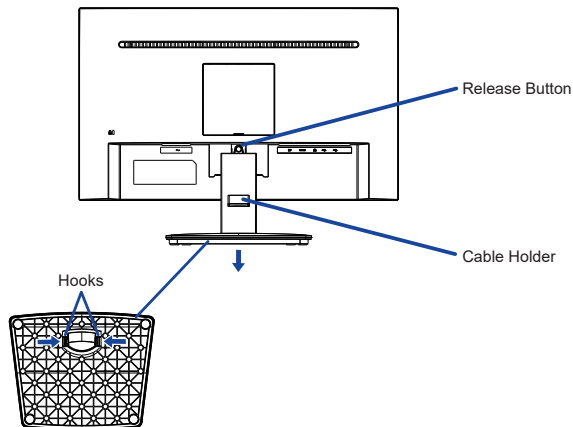

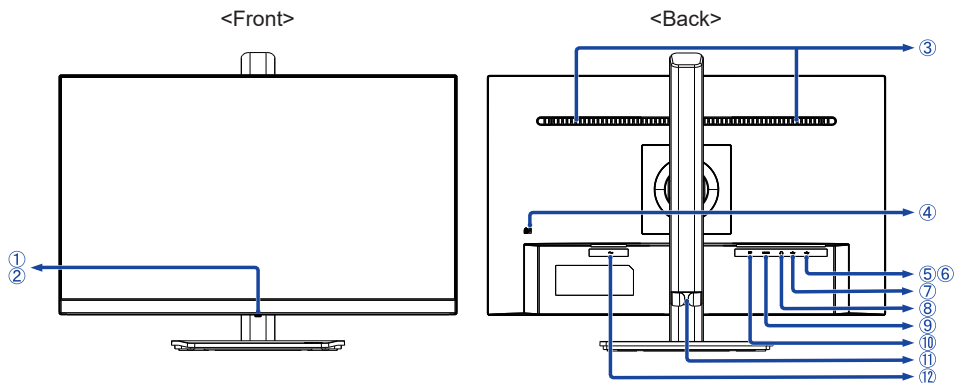

- ① Joystick ^{*1} / Power Button

NOTE A short press turns ON the monitor.
A long press for 5 seconds turns OFF the monitor.

- ② Power Indicator

NOTE Blue: Normal operation
Orange: Standby Mode

- ③ Speakers

- ④ Keyhole for Security Lock

NOTE You can fasten a security lock and cable to prevent the monitor from being removed without your permission.

- ⑤ USB Downstream Connector (USB3.2 Gen 1: 5Gbps, 5V, 900mA) ^{*2}

- ⑥ USB Downstream Connector (USB3.2 Gen 1: 5Gbps, 5V, 900mA) ^{*2}

- ⑦ USB Upstream Connector () ^{*2}

- ⑧ Headphone Connector ()

- ⑨ HDMI Connector (HDMI)

- ⑩ DisplayPort Connector (DP)

- ⑪ Cable Holder

- ⑫ AC Connector (~ : Alternating current)

^{*1} See JOYSTICK on page 16.

^{*2} For ProLite XUB2494HSU, XUB2794HSU

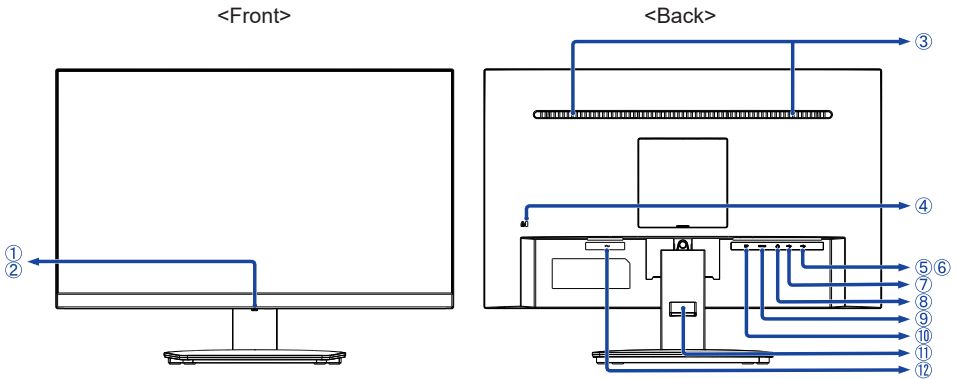

- ① Joystick ^{*1} / Power Button

NOTE A short press turns ON the monitor.
A long press for 5 seconds turns OFF the monitor.

- ② Power Indicator

NOTE Blue: Normal operation
Orange: Standby Mode

- ③ Speakers

- ④ Keyhole for Security Lock

NOTE You can fasten a security lock and cable to prevent the monitor from being removed without your permission.

- ⑤ USB Downstream Connector (USB3.2 Gen 1: 5Gbps, 5V, 900mA) ^{*2}

- ⑥ USB Downstream Connector (USB3.2 Gen 1: 5Gbps, 5V, 900mA) ^{*2}

- ⑦ USB Upstream Connector () ^{*2}

- ⑧ Headphone Connector ()

- ⑨ HDMI Connector (HDMI)

- ⑩ DisplayPort Connector (DP)

- ⑪ Cable Holder

- ⑫ AC Connector (~: Alternating current)

^{*1} See JOYSTICK on page 16.

^{*2} For ProLite XU2494HSU, XU2794HSU

CONNECTING YOUR MONITOR : ProLite XUB2494HS(U), XUB2794HSU

- ① Ensure that both the computer and the monitor are switched off.
- ② Connect the computer to the monitor with the signal cable.
- ③ Connect the computer to the monitor with the USB cable.*
- ④ Connect the Power Cable to the monitor first and then to the power source.
- ⑤ Turn on your monitor and computer.

* For ProLite XUB2494HSU, XUB2794HSU

NOTE

- Make sure that the building installation has a circuit breaker of 120/240V, 20A (maximum).
- The signal cables used for connecting the computer and monitor may vary with the type of computer used. An incorrect connection may cause serious damage to both the monitor and the computer. The cable supplied with the monitor is for a standard connector. If a special cable is required please contact your local iiyama dealer or regional iiyama office.
- The Class I pluggable equipment Type A must be connected to protective earth.
- The socket-outlet shall be installed near the equipment and shall be easily accessible.
- Excessive sound pressure from ear-/headphones can cause hearing damage/hearing loss.

[Example of Connection]

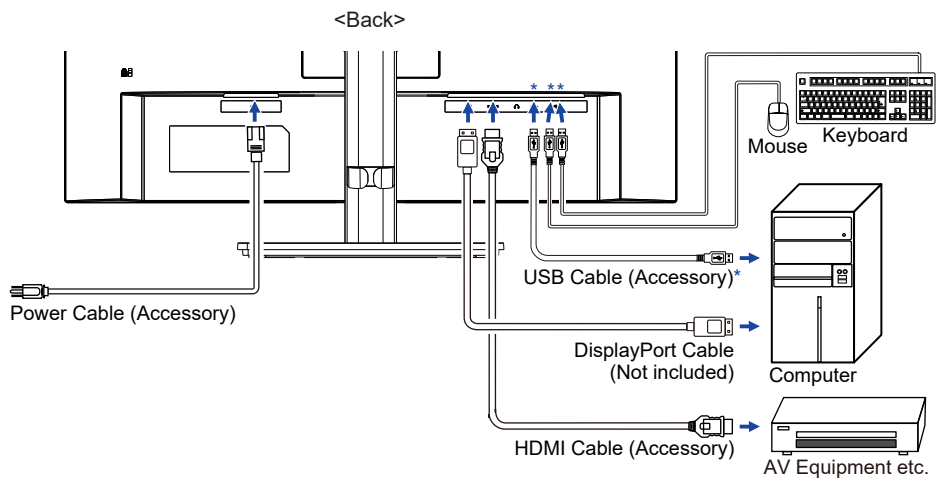

* For ProLite XUB2494HSU, XUB2794HSU

[Collect Cables]

Put the cables through the cable holder to bundle them.

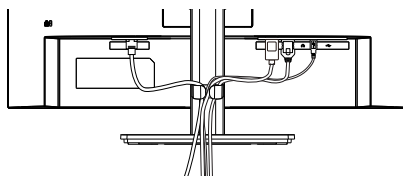

CONNECTING YOUR MONITOR : ProLite XU2494HS(U), XU2794HSU

- ① Ensure that both the computer and the monitor are switched off.
- ② Connect the computer to the monitor with the signal cable.
- ③ Connect the computer to the monitor with the USB cable.*
- ④ Connect the Power Cable to the monitor first and then to the power source.
- ⑤ Turn on your monitor and computer.

* For ProLite XU2494HSU, XU2794HSU

NOTE

- Make sure that the building installation has a circuit breaker of 120/240V, 20A (maximum).
- The signal cables used for connecting the computer and monitor may vary with the type of computer used. An incorrect connection may cause serious damage to both the monitor and the computer. The cable supplied with the monitor is for a standard connector. If a special cable is required please contact your local iiyama dealer or regional iiyama office.
- The Class I pluggable equipment Type A must be connected to protective earth.
- The socket-outlet shall be installed near the equipment and shall be easily accessible.
- Excessive sound pressure from ear-/headphones can cause hearing damage/hearing loss.

[Example of Connection]

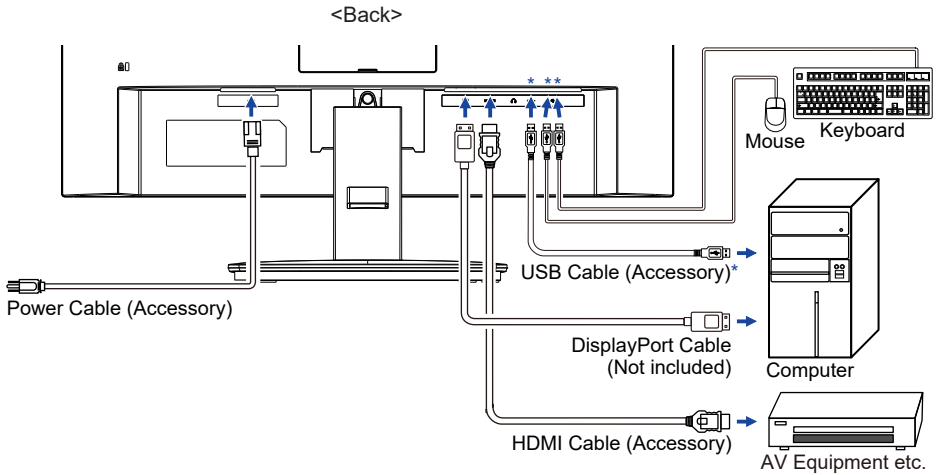

* For ProLite XU2494HSU, XU2794HSU

[Collect Cables]

Put the cables through the cable holder to bundle them.

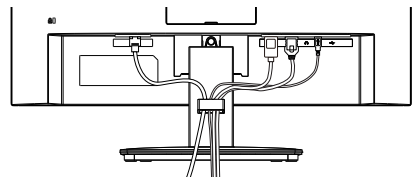

COMPUTER SETTING

■ Signal Timing

Change to the desired signal timing listed on page 36: COMPLIANT TIMING.

ADJUSTING THE HEIGHT AND THE VIEWING ANGLE : ProLite XUB2494HS(U), XUB2794HSU

- For optimal viewing it is recommended to position yourself directly opposite to the full face of the monitor, then adjust the monitor's height and angle to your own preference.
- Hold the panel so that the monitor does not topple when you change the monitor's height or angle.

ProLite XUB2494HS(U)-B2 / XUB2794HSU-B1

- You are able to adjust the monitor's height up to 150mm, angle up to 45° right and left, 23° upward and 5° downward.

ProLite XUB2494HS(U)-B2 A / XUB2794HSU-B1 A

- The monitor height can be adjusted up to 150mm, the panel tilt angle can be adjusted up 23° and down 5°, and the Stand-Base can be swiveled 360° around.

NOTE

- Do not touch the LCD screen when you change the height or the angle. It may cause damage or break the LCD screen.
- Careful attention is required not to pinch your fingers or hands into the moving part of the stand when you change the height or the angle.
- Injury can occur if care is not taken to avoid finger contact with the displays base when adjusting the height.

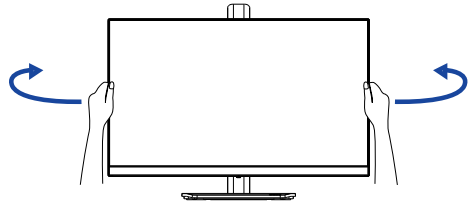
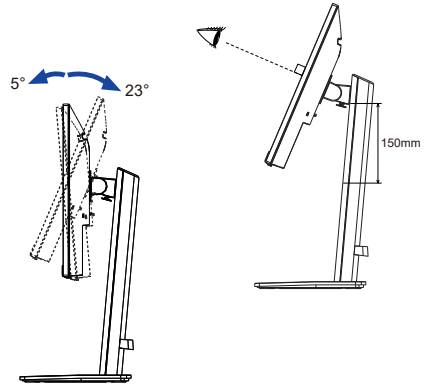

ProLite XUB2494HS(U)-B2 / XUB2794HSU-B1

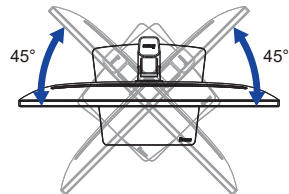

ProLite XUB2494HS(U)-B2 A / XUB2794HSU-B1 A

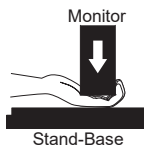
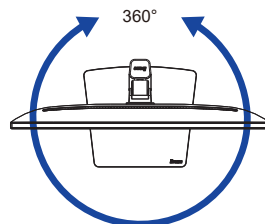

ADJUSTING THE VIEWING ANGLE : ProLite XU2494HS(U), XU2794HSU

- For optimal viewing it is recommended to look at the full face of the monitor.
- Hold the stand so that the monitor does not topple when you change the monitor's angle.
- You are able to adjust the monitor's angle up to 22° upward, 4° downward.
- In order to ensure a healthy and relaxed body position when using the monitor at visual display workstations, it is recommended that the adjusted tilt angle should not exceed 10°. Adjust the monitor's angle to your own preference.

NOTE

- Do not touch the LCD screen when you change the angle. It may cause damage or break the LCD screen.
- Careful attention is required not to pinch your fingers or hands into the moving part of the stand when you change the angle.

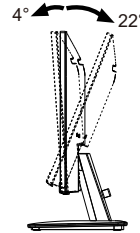
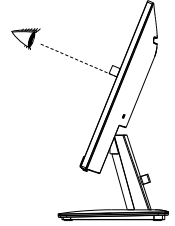

OPERATING THE MONITOR

JOYSTICK

The Joystick can be pressed or tilted in the following five directions.

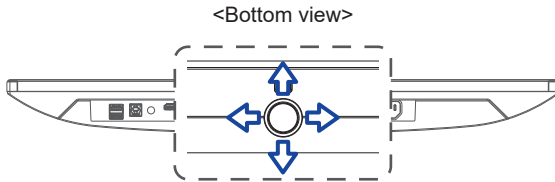
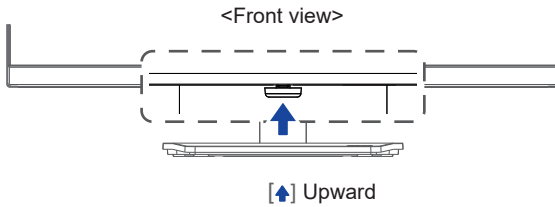

- [↑] Forward: **Direct** i-Style Color / Blue Light Reducer
- [↓] Backward: **Direct** Select Input Source
- [←] Left: **Direct** ECO
- [→] Right: **Direct** Volume

To create the best picture, your iiyama LCD monitor has been preset at the factory with the COMPLIANT TIMING shown on page 36. You are also able to adjust the picture by following the operation shown below.

- ① Press the Joystick [↑] on the monitor to start the On Screen Display feature. There are additional Menu items which can be switched by tilting the Joystick [↔].

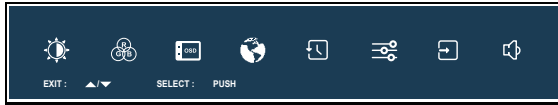

- ② Select the Menu item which contains the adjustment icon relating to the adjustment you want to make. Press the Joystick. Then, tilt the Joystick [↕] to highlight the desired adjustment icon.
- ③ Press the Joystick again. Tilt the Joystick [↔] to make the appropriate adjustment or setting.
- ④ Press the Joystick and then tilt it [↔] to leave the menu, and the settings you just made would be automatically saved.

For example, to correct for OSD vertical position, select Menu item of "OSD" and then press the Joystick. Then, select "OSD Vertical Position" by tilting the Joystick [↕].

An adjustment scale becomes active after you press the Joystick. Then, tilt the Joystick [↔] to change the OSD vertical position settings. The OSD vertical position of the overall display should be changing accordingly while you are doing this.

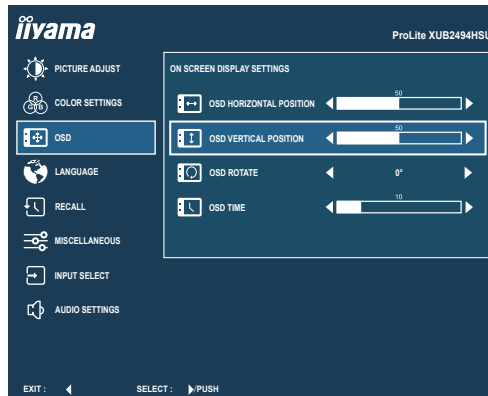

Press or tilt the Joystick [↕] and finally tilt it [↔] to close the On Screen Display feature. All changes are saved in the memory.

NOTE

- When the Joystick operations are aborted during adjustment, On-Screen Display disappears when the time set for the "OSD Time" has passed. Also, tilting the Joystick [↕] can be used to return previous menu and turn off the On Screen Display.
- Any changes are automatically saved in the memory when the On Screen Display disappears. Turning off the power should be avoided while using the Menu.

ADJUSTMENT MENU CONTENTS



Adjustment Item	Problem / Option		Joystick
Brightness *2,3,4	Too dark Too bright		
Contrast *3	Too dull Too intense		
ECO *3 Direct	Off	Normal	
	Mode 1	Brightness of back-light is reduced.	
	Mode 2	Brightness of back-light is reduced more than Mode 1.	
	Mode 3	Brightness of back-light is reduced more than Mode 2.	
Blue Light Reducer Direct	Off	Typical	
	Mode 1	Blue light is reduced.	
	Mode 2	Blue light is reduced more than Mode 1.	
	Mode 3	Blue light is reduced more than Mode 2.	
Adv. Contrast *4	On	Increased Contrast Ratio	
	Off	Typical Contrast Ratio	
Overdrive	Off / 1 / 2 / 3	It will improve the gray level response time of the LCD panel. A higher level results in a faster response time.	

- *1 Disabled when "i-Style Color" is activated.
- *2 Adjust the Brightness when you are using the monitor in a dark room and feel the screen is too bright.
- *3 Disabled when "Adv. Contrast" is activated.
- *4 Disabled when "ECO" is activated.

Direct

You can skip the Menu items and directly display an option setting screen by using the following operations.

- ECO : Tilt the Joystick [↔] with no Menu displayed.
- Blue Light Reducer : Tilt the Joystick forward for 3 seconds with no Menu displayed.



Color Settings

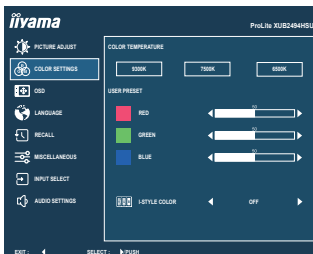

Adjustment Item	Problem / Option	Joystick	
Color Temperature *1	9300K	Cool color	
	7500K	Normal color	
	6500K	Warm color	
User Preset *1	Red		
	Green		Too weak
	Blue		Too strong
i-Style Color *2	Off	Return to a state set by color adjustment except i-Style Color.	
	Standard	For general windows environment and monitor default setting.	
	Game	For PC game environment.	
	Cinema	For movie and video environment.	
	Scenery	For displaying outdoor scenery images	
	Text	For text editing and viewing in a word processing environment.	

*1 Disabled when "i-Style Color" or "Blue Light Reducer" is activated.









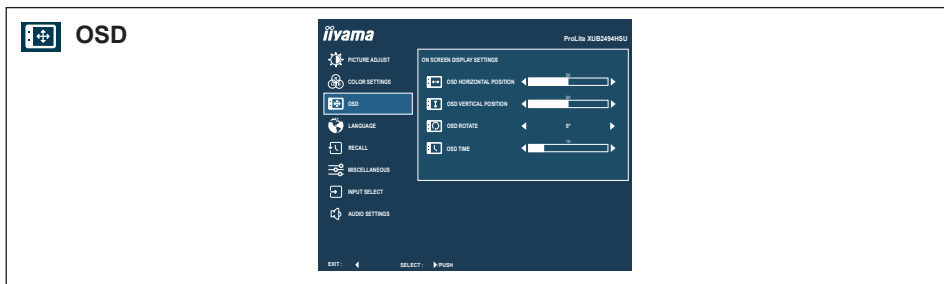







*2 Disabled when "Blue Light Reducer" is activated.

Direct

You can skip the Menu items and directly display an option setting screen by using the following operations.

- i-Style Color : Tilt the Joystick forward with no Menu displayed.



Adjustment Item	Problem / Option	Joystick
OSD Horizontal Position	OSD is too left OSD is too right	   
OSD Vertical Position	OSD is too low OSD is too high	   
OSD Rotate *	Rotate the OSD. 0° (Normal) / +90° (Rotate right) / -90° (Rotate left)	   
OSD Time	You can set the OSD display duration time between 5 and 30 seconds.	   

* For **ProLite XUB2494HS(U)**, **XUB2794HSU** only.

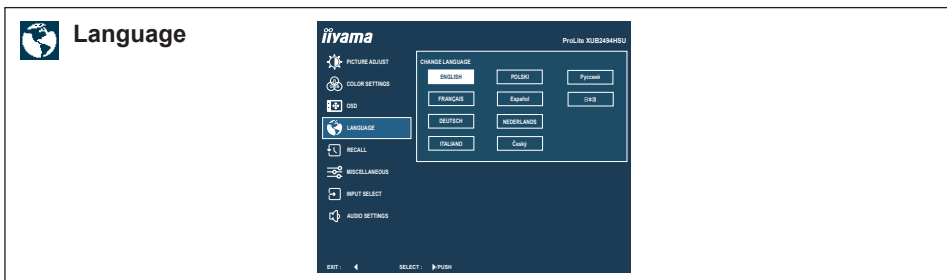

Adjustment Item	Option			
Language	English	English	Español	Spanish
	Français	French	Nederlands	Dutch
	Deutsch	German	Český	Czech
	Italiano	Italian	Русский	Russian
	Polski	Polish	日本語	Japanese

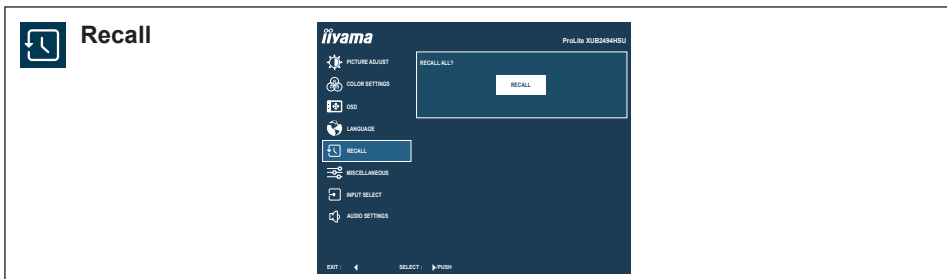

Adjustment Item	Option
Recall	Factory-preset data is restored.



Miscellaneous

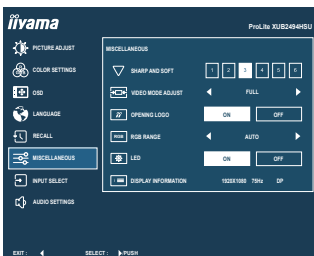

Adjustment Item	Problem / Option		Joystick
Sharp and Soft	1 2 3 4 5 6 You can change the picture quality from 1 to 6 (sharp to soft). Tilt [↔] to change the picture quality in numerical order. Tilt [↔] to change the picture quality in reverse numerical order.		
Video Mode Adjust	Full	Full screen display	
	Aspect *1	Expansion display of Aspect	
Opening Logo	On	iiyama Logo is displayed when the monitor is turned on.	
	Off	iiyama Logo is not displayed when the monitor is turned on.	
RGB Range	Auto	Automatically select color scale signal.	
	Full	For full-range color scale signal	
	Limited	For limited color scale signal	
LED *2	On	The Power Indicator is turned On.	
	Off	The Power Indicator is turned Off.	
Display Information	Displays information regarding the current input signal coming from the graphics card in your computer.		
	NOTE See your graphics card user guide for more information about changing the resolution and refresh.		

*1 Option is unavailable with 16:9 resolution.

*2 For **ProLite XUB2494HS(U)-B2 A, XUB2794HSU-B1 A, XU2494HS(U)-B2 and XU2794HSU-B1**



Input Select

Direct

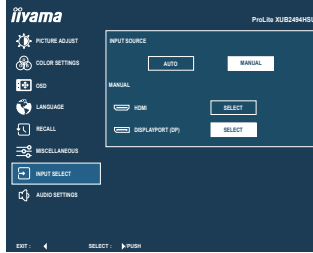

Adjustment Item	Option	
Input Source	Auto	Search for an available input source and select automatically.
	Manual	HDMI
DisplayPort		Select the Digital (DisplayPort) input.

NOTE "Auto" function enables automatic selection of the input sources available. The input source from the computer in standby mode can not be selected. If you manually select one of the input sources, the other source is not automatically selected.



ENGLISH

Direct

You can skip the Menu items and directly display an option setting screen by using the following operations.

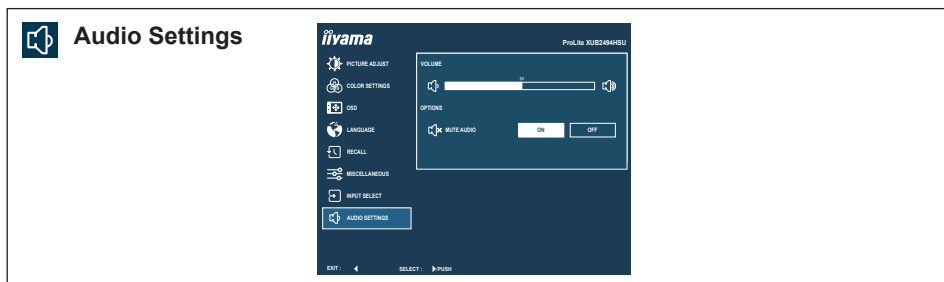
- Input Select : Tilt the Joystick backward with no Menu displayed.



Adjustment Item	Problem / Option		Joystick
Volume Direct	Too soft Too loud		 
Mute Audio	On	Turn off the sound temporarily.	
	Off	Return the sound volume to the previous level.	

Direct

You can skip the Menu items and directly display an adjustment scale by using the following button operations.

- Volume : Tilt the Joystick [] with no Menu displayed.

■ Lock Mode

<OSD Menu>

The OSD can be locked to avoid an accidental setting change.

1. Make sure the monitor is turned ON.
2. The OSD lock will be activated by tilting the Joystick [↔] for about 10 seconds. If you try to access the OSD by the Joystick, a message "OSD Locked" will appear on the screen.
3. The OSD lock will be deactivated by tilting the Joystick [↔] again for about 10 seconds.

<Power Button Function>

The Power Button function can be locked to avoid an accidental power operation.

1. Make sure the monitor is turned ON.
2. The Power Button function will be locked by tilting the Joystick [↔] for about 10 seconds. If you try to turn off the monitor by pressing the Joystick, a message "Power Button Locked" will appear on the screen.
3. The Power Button function will be unlocked by tilting the Joystick [↔] again for about 10 seconds.

STANDBY FEATURE

This product features the standby function. When activated, it automatically reduces unnecessary power consumption of the monitor when your computer is not in use.

There is a standby step the monitor takes as described below. The standby function, including any timer settings is configured by the operating system. Check your operating system manual for information on how this can be configured.

■ Standby Mode

When the video signal from the computer is off, the monitor enters into Standby Mode which reduces the power consumption to less than 0.5W*. The screen becomes dark, and the power indicator turns to orange. From Standby Mode, the image reappears in several seconds when either the keyboard or the mouse are touched again.

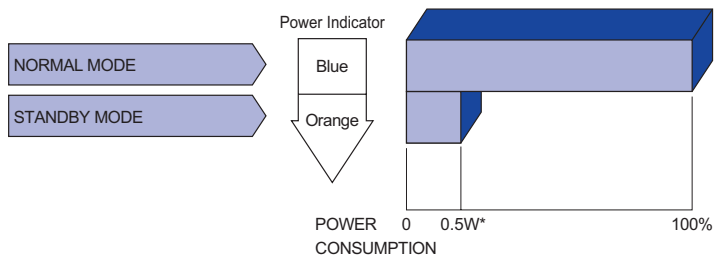

* When the USB devices are not connected. (For [ProLite XU\(B\)2494HSU](#), [XU\(B\)2794HSU](#))

TROUBLE SHOOTING

If the monitor fails to operate correctly, please follow the steps below for a possible solution.

1. Perform the adjustments described in OPERATING THE MONITOR, depending on the problem you have. If the monitor does not get a picture, skip to 2.
2. Consult the following items if you cannot find an appropriate adjustment item in OPERATING THE MONITOR or if the problem persists.
3. If you are experiencing a problem which is not described below or you cannot correct the problem, discontinue using the monitor and contact your dealer or iiyama service center for further assistance.

Problem	Check
① The picture does not appear. (Power indicator does not light up.) (Power indicator is blue.) (Power indicator is orange.)	<input type="checkbox"/> The Power Cable is firmly seated in the socket. <input type="checkbox"/> The Power Button is turned ON. <input type="checkbox"/> The AC socket is live. Please check with another piece of equipment. <input type="checkbox"/> If the blank screen saver is in active mode, touch the keyboard or the mouse. <input type="checkbox"/> Increase the Contrast and/or Brightness. <input type="checkbox"/> The computer is ON. <input type="checkbox"/> The Signal Cable is properly connected. <input type="checkbox"/> The signal timing of the computer is within the specification of the monitor. <input type="checkbox"/> If the monitor is in standby mode, touch the keyboard or the mouse. <input type="checkbox"/> The computer is ON. <input type="checkbox"/> The Signal Cable is properly connected. <input type="checkbox"/> The signal timing of the computer is within the specification of the monitor.
② The screen is not synchronized.	<input type="checkbox"/> The Signal Cable is properly connected. <input type="checkbox"/> The signal timing of the computer is within the specification of the monitor.
③ The screen position is not in the center.	<input type="checkbox"/> The signal timing of the computer is within the specification of the monitor.
④ The screen is too bright or too dark.	<input type="checkbox"/> The video output level of the computer is within the specification of the monitor.
⑤ The screen is shaking.	<input type="checkbox"/> The power voltage is within the specification of the monitor. <input type="checkbox"/> The signal timing of the computer is within the specification of the monitor.
⑥ No sound.	<input type="checkbox"/> The audio equipment (computer etc.) is ON. <input type="checkbox"/> The Volume is turned up. <input type="checkbox"/> The Mute is OFF. <input type="checkbox"/> The audio output level of the audio equipment is within the specification of the monitor.
⑦ The sound is too loud or too quiet.	<input type="checkbox"/> The audio output level of the audio equipment is within the specification of the monitor.

RECYCLING INFORMATION

For better environment protection please don't dispose your monitor.
Please visit our web site: <https://iiyama.com> for monitor recycling.

APPENDIX

Design and specifications are subject to change without prior notice.

SPECIFICATIONS : ProLite XUB2494HSU-B2 / ProLite XUB2494HS-B2

		ProLite XUB2494HSU-B2	ProLite XUB2494HS-B2
Size Category		24"	
LCD Panel	Panel technology	VA	
	Size	Diagonal: 23.8" (60.5cm)	
	Pixel pitch	0.275mm H × 0.275mm V	
	Brightness	250cd/m ² (Typical), 175cd/m ² (Default / Energy Saving)	
	Contrast ratio	3000 : 1 (Typical), Adv. Contrast Function Available	
	Viewable angle	Right / Left: 89 degrees each, Up / Down: 89 degrees each (Typical)	
	Response time	4ms (Gray to Gray)	
Display Colors		Approx. 16.7M	
Sync Frequency		Horizontal: 30.0-85.0kHz, Vertical: 55-75Hz	
Native Resolution		1920 × 1080, 2.1 MegaPixels	
Support max. resolution		HDMI / DisplayPort: 1920 × 1080 75Hz	
Input Connector		HDMI ×1, DisplayPort ×1	
Input Video Signal		HDMI, DisplayPort	
USB Standard		USBUSB3.2 Gen 1 (5Gbps, DC5V, 900mA)	-
Number of USB Ports Connector shape		1 Upstream: Series B 2 Downstream: Series A	-
Headphone Connector		ø 3.5mm mini jack (Stereo)	
Speakers		2W × 2 (Stereo speakers)	
Maximum Screen Size		527.0mm W × 296.5mm H / 20.7" W × 11.7" H	
Power Source		100-240VAC, 50/60Hz, 1.5A	
Power Consumption		19W typical * ¹	19W typical
		Standby mode: 0.5W maximum, Off mode: 0.3W maximum	
Dimensions * ²		540.0 × 373.5 - 523.5 × 224.5(209.5)mm / 21.3 × 14.7 - 20.6 × 8.8(8.2)" (W×H×D)	
Net Weight		4.8kg / 10.6lbs	
Height Adjustment Range		150mm	
Angle		Tilt: Upward: 23 degrees, Downward: 5 degrees Swivel: Left / Right: 45 degrees each Rotation: Clockwise / Counterclockwise: 90 degrees each	
Environmental Considerations		Operating: Temperature 5 to 35°C / 41 to 95°F Humidity 10 to 90% (No condensation) Storage: Temperature -20 to 60°C / -4 to 140°F Humidity 10 to 90% (No condensation)	
Approvals		CE, UKCA, TÜV-Bauart, VCCI, PSE	

NOTE *¹ When the USB devices are not connected.

*² () : Depth of the Stand-Base

SPECIFICATIONS : ProLite XUB2494HSU-B2 A / ProLite XUB2494HS-B2 A

ENGLISH

		ProLite XUB2494HSU-B2 A	ProLite XUB2494HS-B2 A
Size Category		24"	
LCD Panel	Panel technology	VA	
	Size	Diagonal: 23.8" (60.5cm)	
	Pixel pitch	0.275mm H × 0.275mm V	
	Brightness	250cd/m ² (Typical), 175cd/m ² (Default / Energy Saving)	
	Contrast ratio	3000 : 1 (Typical), Adv. Contrast Function Available	
	Viewable angle	Right / Left: 89 degrees each, Up / Down: 89 degrees each (Typical)	
	Response time	4ms (Gray to Gray)	
Display Colors		Approx. 16.7M	
Sync Frequency		Horizontal: 30.0-85.0kHz, Vertical: 55-75Hz	
Native Resolution		1920 × 1080, 2.1 MegaPixels	
Support max. resolution		HDMI / DisplayPort: 1920 × 1080 75Hz	
Input Connector		HDMI ×1, DisplayPort ×1	
Input Video Signal		HDMI, DisplayPort	
USB Standard		USB3.2 Gen 1 (5Gbps, DC5V, 900mA)	-
Number of USB Ports Connector shape		1 Upstream: Series B 2 Downstream: Series A	-
Headphone Connector		ø 3.5mm mini jack (Stereo)	
Speakers		2W × 2 (Stereo speakers)	
Maximum Screen Size		527.0mm W × 296.5mm H / 20.7" W × 11.7" H	
Power Source		100-240VAC, 50/60Hz, 1.5A	
Power Consumption		19W typical ^{*1}	19W typical
		Standby mode: 0.5W maximum, Off mode: 0.3W maximum	
Dimensions ^{*2}		540.0 × 373.5 - 523.5 × 224.5(209.5)mm / 21.3 × 14.7 - 20.6 × 8.8(8.2)" (W×H×D)	
Net Weight		4.8kg / 10.6lbs	
Height Adjustment Range		150mm	
Angle		Tilt: Upward: 23 degrees, Downward: 5 degrees Swivel: 360 degrees Rotation: Clockwise / Counterclockwise: 90 degrees each	
Environmental Considerations		Operating: Temperature 5 to 35°C / 41 to 95°F Humidity 10 to 90% (No condensation) Storage: Temperature -20 to 60°C / -4 to 140°F Humidity 10 to 90% (No condensation)	
Approvals		CE, UKCA, TÜV-Bauart, VCCI, PSE	

NOTE ^{*1} When the USB devices are not connected.

^{*2} () : Depth of the Stand-Base

SPECIFICATIONS : ProLite XU2494HSU-B2 / ProLite XU2494HS-B2

		ProLite XU2494HSU-B2	ProLite XU2494HS-B2
Size Category		24"	
LCD Panel	Panel technology	VA	
	Size	Diagonal: 23.8" (60.5cm)	
	Pixel pitch	0.275mm H × 0.275mm V	
	Brightness	250cd/m ² (Typical), 175cd/m ² (Default / Energy Saving)	
	Contrast ratio	3000 : 1 (Typical), Adv. Contrast Function Available	
	Viewable angle	Right / Left: 89 degrees each, Up / Down: 89 degrees each (Typical)	
	Response time	4ms (Gray to Gray)	
Display Colors		Approx. 16.7M	
Sync Frequency		Horizontal: 30.0-85.0kHz, Vertical: 55-75Hz	
Native Resolution		1920 × 1080, 2.1 MegaPixels	
Support max. resolution		HDMI / DisplayPort: 1920 × 1080 75Hz	
Input Connector		HDMI ×1, DisplayPort ×1	
Input Video Signal		HDMI, DisplayPort	
USB Standard		USB3.2 Gen 1 (5Gbps, DC5V, 900mA)	-
Number of USB Ports Connector shape		1 Upstream: Series B 2 Downstream: Series A	-
Headphone Connector		ø 3.5mm mini jack (Stereo)	
Speakers		2W × 2 (Stereo speakers)	
Maximum Screen Size		527.0mm W × 296.5mm H / 20.7" W × 11.7" H	
Power Source		100-240VAC, 50/60Hz, 1.5A	
Power Consumption		19W typical *	19W typical
		Standby mode: 0.5W maximum, Off mode: 0.3W maximum	
Dimensions		540.0 × 400.5 × 200.0mm / 21.3 × 15.8 × 7.9" (W×H×D)	
Net Weight		3.2kg / 7.0lbs	
Tilt Angle		Upward: 22 degrees, Downward: 4 degrees	
Environmental Considerations		Operating: Temperature	5 to 35°C / 41 to 95°F
		Humidity	10 to 90% (No condensation)
		Storage: Temperature	-20 to 60°C / -4 to 140°F
		Humidity	10 to 90% (No condensation)
Approvals		CE, UKCA, TÜV-Bauart, VCCI, PSE	

NOTE * When the USB devices are not connected.

SPECIFICATIONS : ProLite XUB2794HSU-B1 / ProLite XUB2794HSU-B1 A

ENGLISH

		ProLite XUB2794HSU-B1	ProLite XUB2794HSU-B1 A
Size Category		27"	
LCD Panel	Panel technology	VA	
	Size	Diagonal: 27" (68.5cm)	
	Pixel pitch	0.311mm H × 0.311mm V	
	Brightness	250cd/m ² (Typical), 165cd/m ² (Default / Energy Saving)	
	Contrast ratio	3000 : 1 (Typical), Adv. Contrast Function Available	
	Viewable angle	Right / Left: 89 degrees each, Up / Down: 89 degrees each (Typical)	
	Response time	4ms (Gray to Gray)	
Display Colors		Approx. 16.7M	
Sync Frequency		Horizontal: 30.0-85.0kHz, Vertical: 55-75Hz	
Native Resolution		1920 × 1080, 2.1 MegaPixels	
Support max. resolution		HDMI / DisplayPort: 1920 × 1080 75Hz	
Input Connector		HDMI ×1, DisplayPort ×1	
Input Video Signal		HDMI, DisplayPort	
USB Standard		USB3.2 Gen 1 (5Gbps, DC5V, 900mA)	
Number of USB Ports		1 Upstream: Series B	
Connector shape		2 Downstream: Series A	
Headphone Connector		ø 3.5mm mini jack (Stereo)	
Speakers		2W × 2 (Stereo speakers)	
Maximum Screen Size		596.7mm W × 335.7mm H / 23.5" W × 13.2" H	
Power Source		100-240VAC, 50/60Hz, 1.5A	
Power Consumption * ¹		25W typical Standby mode: 0.5W maximum, Off mode: 0.3W maximum	
Dimensions * ²		615.0 × 396.0 - 546.0 × 224.5(209.5)mm / 24.2 × 15.6 - 21.5 × 8.8(8.2)" (W×H×D)	
Net Weight		5.5kg / 12.0lbs	
Height Adjustment Range		150mm	
Angle	Tilt	Upward: 23 degrees, Downward: 5 degrees	
	Swivel	Left / Right: 45 degrees each	360 degrees
	Rotation	Clockwise / Counterclockwise: 90 degrees each	
Environmental Considerations		Operating: Temperature 5 to 35°C / 41 to 95°F Humidity 10 to 90% (No condensation) Storage: Temperature -20 to 60°C / -4 to 140°F Humidity 10 to 90% (No condensation)	
Approvals		CE, UKCA, TÜV-Bauart, VCCI, PSE	

NOTE *¹ When the USB devices are not connected.

*² () : Depth of the Stand-Base

SPECIFICATIONS : ProLite XU2794HSU-B1

Size Category		27"
LCD Panel	Panel technology	VA
	Size	Diagonal: 27" (68.5cm)
	Pixel pitch	0.311mm H × 0.311mm V
	Brightness	250cd/m ² (Typical), 165cd/m ² (Default / Energy Saving)
	Contrast ratio	3000 : 1 (Typical), Adv. Contrast Function Available
	Viewable angle	Right / Left: 89 degrees each, Up / Down: 89 degrees each (Typical)
	Response time	4ms (Gray to Gray)
Display Colors		Approx. 16.7M
Sync Frequency		Horizontal: 30.0-85.0kHz, Vertical: 55-75Hz
Native Resolution		1920 × 1080, 2.1 MegaPixels
Support max. resolution		HDMI / DisplayPort: 1920 × 1080 75Hz
Input Connector		HDMI ×1, DisplayPort ×1
Input Video Signal		HDMI, DisplayPort
USB Standard		USB3.2 Gen 1 (5Gbps, DC5V, 900mA)
Number of USB Ports		1 Upstream: Series B
Connector shape		2 Downstream: Series A
Headphone Connector		ø 3.5mm mini jack (Stereo)
Speakers		2W × 2 (Stereo speakers)
Maximum Screen Size		596.7mm W × 335.7mm H / 23.5" W × 13.2" H
Power Source		100-240VAC, 50/60Hz, 1.5A
Power Consumption *		25W typical Standby mode: 0.5W maximum, Off mode: 0.3W maximum
Dimensions		615.0 × 442.5 × 220.5mm / 24.2 × 17.4 × 8.7" (W×H×D)
Net Weight		3.9kg / 8.6lbs
Tilt Angle		Upward: 22 degrees, Downward: 4 degrees
Environmental Considerations		Operating: Temperature 5 to 35°C / 41 to 95°F Humidity 10 to 90% (No condensation) Storage: Temperature -20 to 60°C / -4 to 140°F Humidity 10 to 90% (No condensation)
Approvals		CE, UKCA, TÜV-Bauart, VCCI, PSE

NOTE * When the USB devices are not connected.

DIMENSIONS : ProLite XUB2494HS(U)

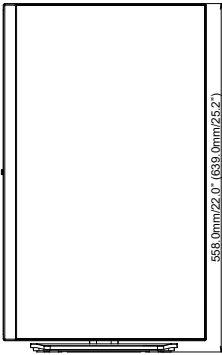
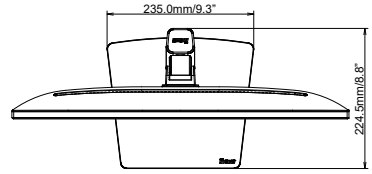
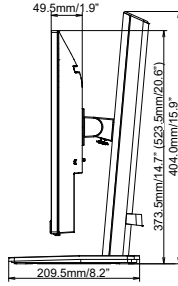
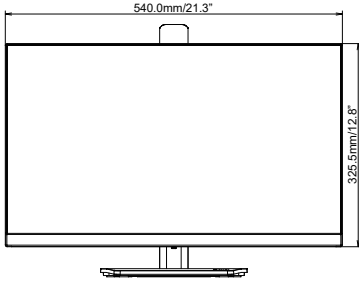

() : Maximum adjustment range

DIMENSIONS : ProLite XU2494HS(U)

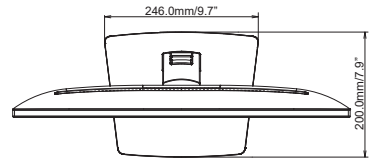
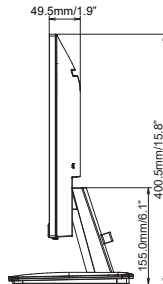
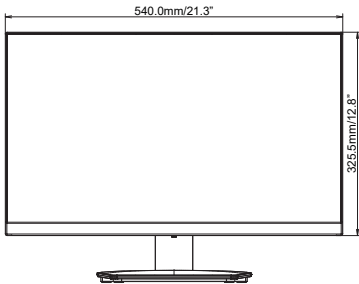

DIMENSIONS : ProLite XUB2794HSU

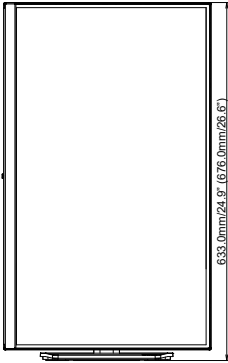
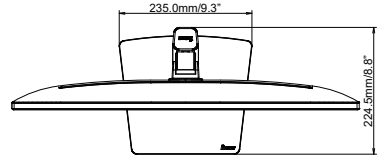
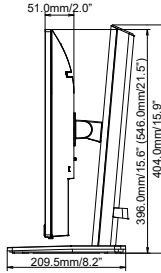
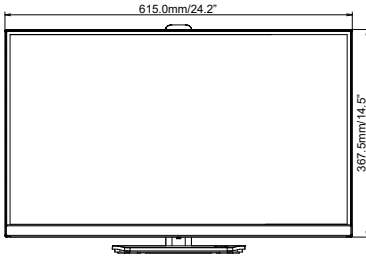

() : Maximum adjustment range

DIMENSIONS : ProLite XU2794HSU

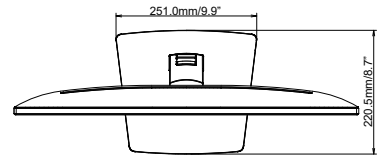
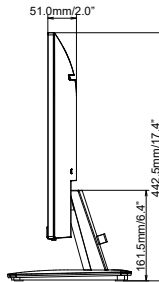
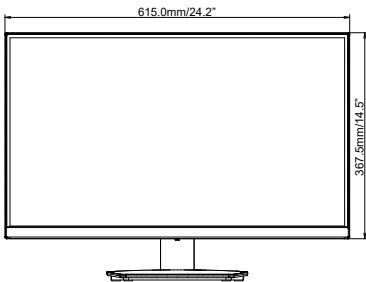

COMPLIANT TIMING

Video Mode	Horizontal Frequency	Vertical Frequency	Dot Clock
640 × 480	31.469kHz	59.940Hz	25.175MHz
800 × 600	37.879kHz	60.317Hz	40.000MHz
1024 × 768	48.363kHz	60.004Hz	65.000MHz
1280 × 1024	63.981kHz	60.020Hz	108.000MHz
1440 × 900	55.935kHz	59.887Hz	106.500MHz
1680 × 1050	65.290kHz	60.000Hz	146.250MHz
1920 × 1080	66.590kHz	59.930Hz	138.500MHz
	83.890kHz	74.970Hz	174.500MHz