

# USER MANUAL

# *ProLite*

## LCD Monitor

ENGLISH

### *ProLite T2454MSC*

Thank you very much for choosing the iiyama LCD monitor.

We recommend that you take a few minutes to read this comprehensive manual carefully before installing and switching on the monitor. Please keep this manual in a safe place for your future reference.



**Dear user, we congratulate you on the purchase of your iiyama LCD.**

For details on warranty and locally used pixel policies that apply directly after installation of your product please check the iiyama website.

**To report a fault, please contact your local support centre found at [www.iiyama.com/service](http://www.iiyama.com/service)**

**Things to check before you call the iiyama information line**

- | if the power cable is connected securely and turned on?
- | if the display has been turned on?
- | if the signal cable is connected securely and the correct input selected?
- | if the computer has been restarted with the display connected?
- | if the graphics card is correctly installed with the latest drivers possible?
- | if the correct native resolution has been selected via 'Display Properties'?
- | If the R/G/B signal configuration is correct?
- | if the displays On Screen Menu is shown?
- | if the correct brightness and contrast settings have been set?
- | if given display tolerances and compatibility have been considered?
- | if via the On Screen Menu you have performed a Factory Reset/Recall?

**Before reporting the screen defect, please prepare the following information/evidence:**

- | model number \*
- | purchase receipt and serial number \*
- | name and address for collection
- | telephone/fax number, for availability during the day
- | convenient collection date (date, time)
- | short description of the defect

**Important Note:**

If there is no fault found in the collected equipment after inspection, the transferring party shall incur charges for transport and administration.

If you have checked all of the above and there is still no picture, call our information line for assistance in your country.

\* see the identification plate on the back of the case.

## CE MARKING DECLARATION OF CONFORMITY

This LCD monitor complies with the requirements of the EC/EU Directive 2014/30/EU "EMC Directive", 2014/35/EU "Low Voltage Directive", 2009/125/EC "ErP Directive" and 2011/65/EU "RoHS Directive".

The electro-magnetic susceptibility has been chosen at a level that gives correct operation in residential areas, business and light industrial premises and small-scale enterprises, inside as well as outside of the buildings. All places of operation are characterised by their connection to the public low voltage power supply system.

IYAMA CORPORATION: Wijkmeerstraat 8, 2131 HA Hoofddorp, The Netherlands

Model No. : PLT2454M



We recommend recycling of used product. Please contact your dealer or iiyama service center. Recycle information is obtained via the Internet, using the address: <http://www.iiyama.com>

You can access the Web page of different countries from there.

- We reserve the right to change specifications without notice.
- All trademarks used in this user manual are the property of their respective owners.
- Eprel registration number T2454MSC-B1AG : 366281

# TABLE OF CONTENTS

FOR YOUR SAFETY .....	1
SAFETY PRECAUTIONS .....	1
SPECIAL NOTES ON LCD MONITORS .....	3
CUSTOMER SERVICE .....	3
CLEANING .....	3
BEFORE YOU OPERATE THE MONITOR .....	4
FEATURES .....	4
CHECKING THE CONTENTS OF THE PACKAGE .....	4
INSTALLATION .....	5
CONTROLS AND CONNECTORS .....	6
CONNECTING YOUR MONITOR .....	7
COMPUTER SETTING .....	8
ADJUSTING THE VIEWING ANGLE .....	10
OPERATING THE MONITOR .....	11
ADJUSTMENT MENU CONTENTS .....	12
SCREEN ADJUSTMENTS .....	18
STANDBY FEATURE .....	21
TROUBLE SHOOTING .....	22
RECYCLING INFORMATION .....	23
APPENDIX .....	24
SPECIFICATIONS .....	24
DIMENSIONS .....	25
COMPLIANT TIMING .....	25

# FOR YOUR SAFETY

## SAFETY PRECAUTIONS

### WARNING

#### **STOP OPERATING THE MONITOR WHEN YOU SENSE TROUBLE**

If you notice any abnormal phenomena such as smoke, strange sounds or fumes, unplug the monitor and contact your dealer or iiyama service center immediately. Further use may be dangerous and can cause fire or electric shock.

#### **NEVER REMOVE THE CABINET**

High voltage circuits are inside the monitor. Removing the cabinet may expose you to the danger of fire or electric shock.

#### **DO NOT PUT ANY OBJECT INTO THE MONITOR**

Do not put any solid objects or liquids such as water into the monitor. In case of an accident, unplug your monitor immediately and contact your dealer or iiyama service center. Using the monitor with any object inside may cause fire, electric shock or damage.

#### **INSTALL THE MONITOR ON A FLAT, STABLE SURFACE**

The monitor may cause an injury if it falls or is dropped.

#### **DO NOT USE THE MONITOR NEAR WATER**

Do not use where water may be splashed or spilt onto the monitor as it may cause fire or electric shock.

#### **OPERATE UNDER THE SPECIFIED POWER SUPPLY**

Be sure to operate the monitor only with the specified power supply. Use of an incorrect voltage will cause malfunction and may cause fire or electric shock.

#### **PROTECT THE CABLES**

Do not pull or bend the power cable and signal cable. Do not place the monitor or any other heavy objects on the cables. If damaged, the cables may cause fire or electric shock.

#### **ADVERSE WEATHER CONDITIONS**

It is advisable not to operate the monitor during a heavy thunder storm as the continual breaks in power may cause malfunction. It is also advised not to touch the plug in these circumstances as it may cause electric shock.

## CAUTION

### INSTALLATION LOCATION

Do not install the monitor where sudden temperature changes may occur, or in humid, dusty or smoky areas as it may cause fire, electric shock or damage. You should also avoid areas where the sun shines directly on the monitor.

### DO NOT PLACE THE MONITOR IN A HAZARDOUS POSITION

The monitor may topple and cause injury if not suitably located. Please also ensure that you do not place any heavy objects on the monitor, and that all cables are routed such that children may not pull the cables and possibly cause injury.

### MAINTAIN GOOD VENTILATION

Ventilation slots are provided to keep the monitor from overheating. Covering the slots may cause fire. To allow adequate air circulation, place the monitor at least 10cm (or 4 inches) from any walls. When removing the tilt stand, the ventilation slots on the back side of the monitor can be blocked. This may overheat the monitor and may cause fire or damage. Make sure to allow enough ventilation when removing the tilt stand. Operating the monitor on its back, side, upside down or on a carpet or any other soft material may also cause damage.

### DISCONNECT THE CABLES WHEN YOU MOVE THE MONITOR

When you move the monitor, turn off the power switch, unplug the monitor and be sure the signal cable is disconnected. If you do not disconnect them, it may cause fire or electric shock.

### UNPLUG THE MONITOR

If the monitor is not in use for a long period of time it is recommended that it is left unplugged to avoid accidents.

### HOLD THE PLUG WHEN DISCONNECTING

To disconnect the power cable or signal cable, always pull it by the plug. Never pull on the cable itself as this may cause fire or electric shock.

### DO NOT TOUCH THE PLUG WITH WET HANDS

Pulling or inserting the plug with wet hands may cause electric shock.

### WHEN YOU INSTALL THE MONITOR ON YOUR COMPUTER

Be sure the computer is strong enough to hold the weight of the monitor, otherwise, you may damage your computer.

### REMARK FOR 24/7 USAGE

This product is not specifically designed for 24/7 usage in all environments.

## OTHERS

### ERGONOMIC RECOMMENDATIONS

To eliminate eye fatigue, do not operate the monitor against a bright background or in a dark room. For optimal viewing comfort, the monitor should be just below eye level and 40-60 cm (16-24 inches) away from your eyes. When using the monitor over a prolonged time, a ten minute break every hour is recommended as looking at the screen continuously can cause eye strain.

## SPECIAL NOTES ON LCD MONITORS

The following symptoms are normal with LCD monitors and do not indicate a problem.

- NOTE**
- When you first turn on the LCD monitor, the picture may not fit in the display area because of the type of computer that is used. In this case, adjust the picture position to the correct position.
  - You may find slightly uneven brightness on the screen depending on the desktop pattern you use.
  - Due to the nature of the LCD screen, an afterimage of the previous screen may remain after switching the image, when the same image is displayed for hours. In this case, the screen can be recovered slowly by changing the image or turning off the Power Switch for some hours.

## CUSTOMER SERVICE

- NOTE**
- If you have to return your unit for service and the original packaging has been discarded, please contact your dealer or iiyama service center for advice or replacement packaging.

## CLEANING

- WARNING**
- If you drop any materials or liquids such as water into the monitor when cleaning, unplug the power cable immediately and contact your dealer or iiyama service center.

- CAUTION**
- For safety reasons, turn off the power switch and unplug the monitor before you clean it.

- NOTE**
- To protect the LCD panel, do not scratch or rub the screen with a hard object.
    - Do not touch the screen with any item harder than a HB pencil lead
    - Avoid using towels, paper towels, tissue paper and abrasive cloths
    - Do not rub the screen using dust wipes with cleaning agents
  - Never use any of the following strong solvents.  
Spraying or pouring liquids directly on the surface on the LCD screen and cabinet can cause damage to them.
 

Thinner	Spray-type cleaner	Bleach
Benzine	Wax	Peroxides (including hydrogen peroxide)
Abrasive cleaner	Acid or Alkaline solvent	Acetone
Ammonia	Ethyl alcohol	Toluene
  - Wipe off saliva and water drops as soon as possible as prolonged contact with polarizer causes deformations and color fading.
  - Touching the cabinet with any product made from rubber or plastic for a long time may cause degeneration or loss of paint on the cabinet.

**CABINET** Stains can be removed with a cloth lightly moistened with a mild detergent solvent. The wipe the cabinet with a soft dry cloth.

**LCD** Periodic cleaning with a soft dry cloth is recommended.

**SCREEN** Remove dust and other particles using a clean microfiber cloth.

1. Moisten a microfiber cloth with a non-ammonia, non-alcohol based, mild non-abrasive detergent.
2. Wipe the screen gently with the moistened cloth.

# BEFORE YOU OPERATE THE MONITOR

## FEATURES

- ◆ Supports Resolutions up to 1920 × 1080
- ◆ High Contrast 1000:1 (Typical: with Touch panel) / Brightness 250cd/m<sup>2</sup> (Typical)
- ◆ Digital Character Smoothing
- ◆ Automatic Set-up
- ◆ Stereo Speakers  
2 × 2W Stereo Speakers
- ◆ Standby Feature
- ◆ VESA Mounting Standard (100mm×100mm) Compliant
- ◆ Keyhole for Security Lock
- ◆ 10point Touch

## CHECKING THE CONTENTS OF THE PACKAGE

The following accessories are included in your package. Check to see if they are enclosed with the monitor. If anything is missing or damaged, please contact your local iiyama dealer or regional iiyama office.

- Power Cable\*<sup>1</sup>
- HDMI Cable
- USB Cable
- Safety Guide
- Quick Start Guide

### CAUTION

\* The rating of the Power Cable enclosed in 120V area is 10A/125V. If you are using a power supply higher than this rating, then a power cable with a rating of 10A/250V must be used. However, all guarantees and warranties are void for any problems or damage caused by a power cable not supplied by iiyama. An approved power cable greater or equal to H05VVVF, 3G, 0.75mm<sup>2</sup> must be used.



## INSTALLATION

### CAUTION

- Before installation, make sure the wall, ceiling or desktop arm is strong enough to hold the necessary weight of the monitor and the mount.

### < WALL MOUNTING >

### CAUTION

- When you use with the wall mounting, in consideration of thickness of the mounting stage, tighten the M4 Screws (4pcs) which "L" length is 7mm to fasten the monitor. Using the screw longer than this may cause electric shock or damage because it may contact with the electrical parts inside the monitor.

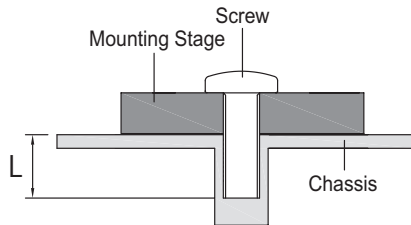

## CONTROLS AND CONNECTORS

<Front>

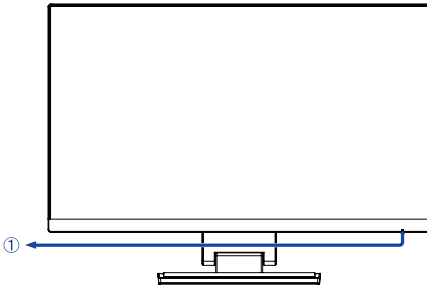

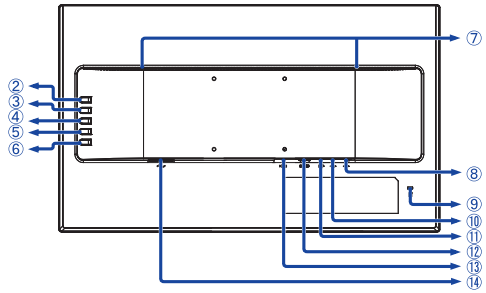

<Back>





- ① Power Indicator

**NOTE** Blue: Normal operation  
Orange: Standby Mode

- ② Auto Button (AUTO)  
③ + Button ( + )  
④ - Button ( - )  
⑤ Menu Button (MENU)  
⑥ Power Switch (  )  
⑦ Speakers  
⑧ USB Downstream Connector (  5V, 900mA)  
⑨ Keyhole for Security Lock

**NOTE** You can fasten a security lock and cable to prevent the monitor from being removed without your permission.

- ⑩ USB Upstream Connector (  )  
⑪ Audio Connector (  )  
⑫ VGA Connector (VGA)  
⑬ HDMI Connector (HDMI)  
⑭ AC Connector( ~ : Alternating current) (AC POWER IN)

## CONNECTING YOUR MONITOR

- ① Ensure that both the computer and the monitor are switched off.
- ② Connect the computer to the monitor with the signal cable.
- ③ Connect the monitor to the audio equipment with the Audio Cable for computer when using the audio features.
- ④ Connect the computer to the monitor with the USB Cable.
- ⑤ Connect the Power Cable to the monitor first and then to the power source.
- ⑥ Turn on your monitor and computer.

### NOTE

- Make sure that the building installation has a circuit breaker of 120/240V, 20A (maximum).
- The signal cables used for connecting the computer and monitor may vary with the type of computer used. An incorrect connection may cause serious damage to both the monitor and the computer. The cable supplied with the monitor is for a standard connector. If a special cable is required please contact your local iiyama dealer or regional iiyama office.
- Make sure you tighten the finger screws at each end of the Signal Cable.
- The Class I pluggable equipment Type A must be connected to protective earth.
- The socket-outlet shall be installed near the equipment and shall be easily accessible.

[Example of Connection]

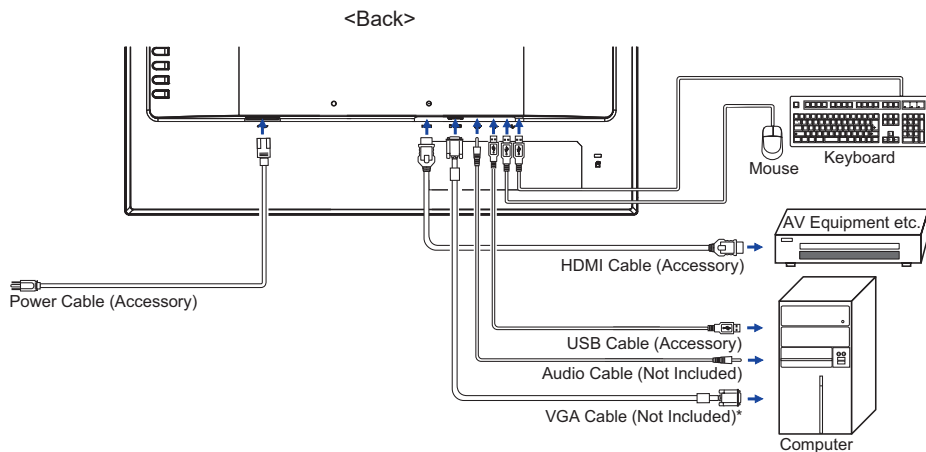

\* VGA cable is not supplied with the monitor. If you use low quality VGA cable, it may cause a result of electro-magnetic interference. Please contact the iiyama Support Centre in your country if you wish to connect the monitor via the VGA input.

## COMPUTER SETTING

### ■ Signal Timing

Change to the desired signal timing listed on page 25: COMPLIANT TIMING.

### ■ TOUCH support operation system

	Mouse	Digitizer	Gestures* <sup>1</sup>
Windows8/8.1/10	○	○	○
Windows7	○	○	○
Windows Vista	○	○	×
Windows XP	×	×	×
Mac OS/OS X	×	×	×
Linux	○	×	×
Android	×	×	×
Functions	Click Drag Double-Click	Mouse function Right-Click Flick Visual feedback	Mouse & Digitizer functions Press & Tap, Rotate, Zoom-in/out

The other OS Versions not listed are not supported.

○ : Supported    × : Not supported

\*<sup>1</sup> Gestures can be supported by application programs.

### ● PALM REJECTION FUNCTION:

Palm rejection is a way to disregard touch made with "a large contact area" while finger modes.

A large contact area : palm, clenched fist, elbow, arm, etc. 30mm<sup>2</sup> or more.

When you touch the screen with a finger, palm rejection is activated and the screen does not recognize touch made with the large contact area.

## ■ Touch Input Settings in Dual Screen Mode

① Connect the primary monitor to the computer first.

Set Control Panel > Hardware and Sound > Tablet PC Settings > Display > Setup.

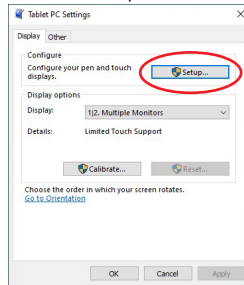
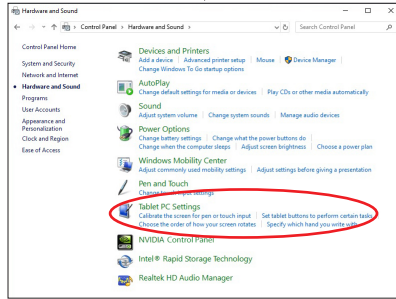
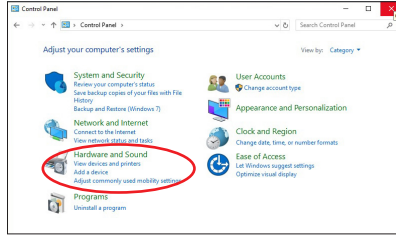

The following message will appear on the screen. Please follow the instructions.

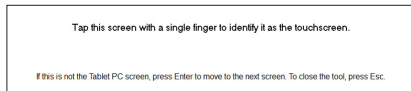

② After setting ①, connect a second monitor and perform the setup as in ①.

**NOTE** The monitors are recognized as dual-display, and touch operation cannot be performed on two monitors at the same time.  
You can perform touch operation on only one of the monitors.

## ADJUSTING THE VIEWING ANGLE

- NOTE**
- Do not touch the Touch screen when you change the angle. It may cause damage or break the Touch screen and LCD screen.
  - Careful attention is required not to pinch your fingers or hands when you change the angle.

- For optimal viewing it is recommended to look at the full face of the monitor.
- You are able to adjust the monitor's height up to 388mm - 128mm, angle up to 90 degrees upward and 5 degrees downward.
- Hold the stand so that the monitor does not topple when you change the monitor's angle.

- ① Place the monitor on a flat surface.
- ② Hold the panel so the monitor does not topple.
- ③ We recommend that you adjust the stand to its lowest position when using the monitor in the 90 degree upward tilt position.

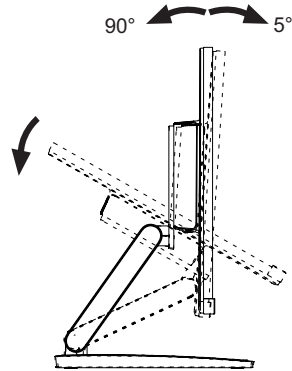
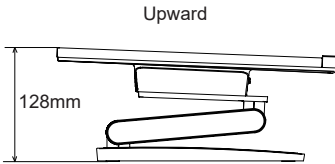

# OPERATING THE MONITOR

To create the best picture, your iiyama LCD monitor has been preset at the factory with the COMPLIANT TIMING shown on page 25. You are also able to adjust the picture by following the button operation shown below. For more detailed adjustments, see page 18 for SCREEN ADJUSTMENTS.

- ① Press the MENU Button to start the On Screen Display feature. There are additional Menu items which can be switched by using the + / - Buttons.



- ② Select the Menu item which contains the adjustment icon relating to the adjustment you want to make. Press the MENU Button. Then, use the + / - Buttons to highlight the desired adjustment icon.
- ③ Press the MENU Button again. Use the + / - Buttons to make the appropriate adjustment or setting.
- ④ Press the AUTO Button to leave the menu, and the settings you just made would be automatically saved.

For example, to correct for vertical position, select Menu item of Geometry and then press the MENU Button. Then, select Vertical Position by using the + / - Buttons.

An adjustment page appears after you press the MENU Button. Then, use the + / - Buttons to change the vertical position settings. The vertical position of the overall display should be changing accordingly while you are doing this.

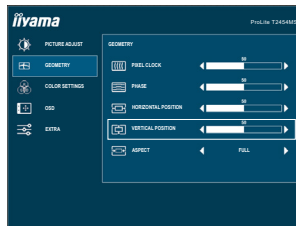

Press the AUTO Button lastly, it ends, all changes are saved in the memory.

## NOTE

- When button operations are aborted during adjustment, On-Screen Display disappears when the time set for the Timeout has passed. Also, the AUTO button can be used to return previous menu and turn off the On-Screen Display.
- Any changes are automatically saved in the memory when the On Screen Display disappears. Turning off the power should be avoided while using the Menu.
- Adjustments for Horizontal / Vertical Position, Pixel Clock and Phase are saved for each signal timing. Except for these adjustments, all other adjustments have only one setting which applies to all signal timings.

# ADJUSTMENT MENU CONTENTS



## Picture Adjust

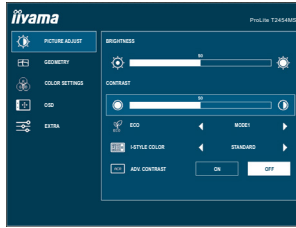

Adjustment Item	Problem / Option		Button to Press
Brightness * <sup>1</sup>	Too dark Too bright		+ -
Contrast	Too dull Too intense		+ -
Eco <span style="float: right; background-color: #0056b3; color: white; padding: 2px 5px; border-radius: 3px;">Direct</span>	Off	Normal	
	Mode1	Brightness of back-light is reduced.	
	Mode2	Brightness of back-light is reduced more than Mode1.	
	Mode3	Brightness of back-light is reduced more than Mode2.	
i-Style Color * <sup>2</sup>	Standard	For general windows environment and monitor default setting.	
	Text	For text editing and viewing in a word processing environment.	
	Internet	For internet environment.	
	Game	For PC game environment.	
	Movie	For movie and video environment.	
Adv. Contrast	Sport	For sport environment.	
	Off	Typical Contrast Ratio	
	On	Increased Contrast Ratio	
<p><b>NOTE</b> Adv. Contrast adjusts brightness according to the image, and improve the contrast ratio during movie playing.                      Contrast, Brightness, Color Settings, Eco and i-Style Color cannot be adjusted and selected while Adv. Contrast is active.</p>			

\*<sup>1</sup> Adjust the Brightness when you are using the monitor in a dark room and feel the screen is too bright.

\*<sup>2</sup> i-Style Color is disabled when Blue Light Reducer is activated.

### Direct

You can skip the Menu items and display an adjustment scale directly by using the following button operations.









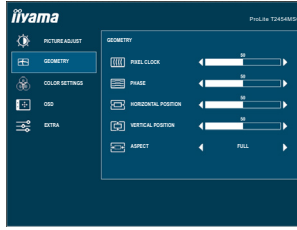













- Eco: Press the - Button when the Menu is not displayed.





# Geometry



Adjustment Item	Problem / Option	Button to Press
Pixel Clock* <sup>1,2</sup>	 Too narrow  Too wide	   
Phase* <sup>1,2</sup>	To correct flickering text or lines	   
Horizontal Position* <sup>2</sup>	 Too left  Too right	   
Vertical Position* <sup>2</sup>	 Too low  Too high	   
Aspect	Full	Expansion display
	Aspect	Expansion display of Aspect



\*<sup>1</sup> See page 18 for SCREEN ADJUSTMENTS.

\*<sup>2</sup> Only Analog Input.



## Color Settings\*



Adjustment Item	Problem / Option		Button to Press
Gamma	Mode1	Normal	
	Mode2	High contrast	
	Mode3	Dark	
Color Temp	User	Red	Too weak  <input type="button" value="+"/> Too strong  <input type="button" value="-"/>
		Green	
		Blue	
	Cool	Bluish white	
	Normal	Yellowish white	
Warm	Greenish white		
sRGB	sRGB		

### NOTE





- sRGB is an international standard which defines and unifies the difference of color appearance between equipment.
- You can not adjust the Brightness, Contrast, Gamma and Eco during sRGB mode because those settings are locked.

\* Color Settings adjustments is disabled when Blue Light Reducer is activated.

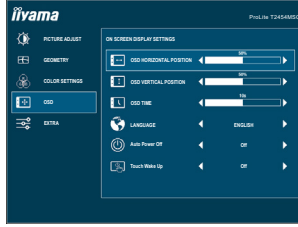

# OSD



Adjustment Item	Problem / Option	Button to Press		
OSD Horizontal Position	OSD is too left	 <input type="button" value="+"/>		
	OSD is too right	 <input type="button" value="-"/>		
OSD Vertical Position	OSD is too low	 <input type="button" value="+"/>		
	OSD is too high	 <input type="button" value="-"/>		
OSD Time	You can set the OSD display duration time between 5 and 60 seconds.	 <input type="button" value="+"/> <input type="button" value="-"/>		
Language	English	English	日本語	Japanese
	Deutsch	German	Nederlands	Dutch
	Español	Spanish	Polski	Polish
	Français	French	Portuguese	Portuguese
	Italiano	Italian	Русский	Russian
Auto Power Off	Off	Auto Power Off is turned off.		
	On	The monitor will turn off automatically after 3 hours without any key operation.		
Touch Wake Up	Off	Touch Wake Up is turned off.		
	On	Touch and USB hub still functional during the display stand by.		

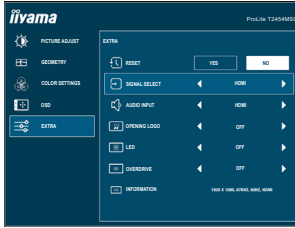

Adjustment Item	Problem / Option		Button to Press
Reset	Yes	Factory-preset data is restored.	
	No	Return to Menu.	
Signal Select <span style="background-color: #0056b3; color: white; padding: 2px 5px; font-weight: bold;">Direct</span>	Auto	Select the signal input automatically.	
	VGA	Select the Analog input.	
	HDMI	Select the Digital (HDMI) input.	
<p><b>NOTE</b> At selected the AUTO, it will automatically be selected when just one source is available. If there are more input sources available and you select one of them, the AUTO option is not available.</p> <p>If multiple inputs are connected, the monitor may not recover the last one used after turning it off and on again.</p> <p>It is only possible when you set a specific source.</p>			
Audio Input*1	HDMI	Select the HDMI input.	
	LINE IN	Select the LINE IN input.	
Opening Logo	Off	iiyama Logo does not display when the monitor is turned on.	
	On	iiyama Logo displayed when the monitor is turned on.	
LED	Off	The Power Indicator is turned Off.	
	On	The Power Indicator is turned On.	
<p><b>NOTE</b> Turn Off the Power Indicator when you are bothered by the light.</p>			
Overdrive*2	Off / -2 / -1 / 0 / +1 / +2	It will improve the gray level response time of the LCD panel. A higher level results in a faster response time.	 <div style="display: inline-block; border: 1px solid black; padding: 2px 5px; margin: 0 5px;">+</div> <div style="display: inline-block; border: 1px solid black; padding: 2px 5px; margin: 0 5px;">-</div>
Information	Displays information regarding the current input signal coming from the graphic card in your computer.		
<p><b>NOTE</b> See your graphic card user guide for more information about changing the resolution and refresh.</p>			

\*1 Suitable for HDMI input only.

\*2 When Overdrive is activated, some level of image retention will be caused.

## Direct

You can skip the Menu items and display an adjustment scale directly by using the following button operations.

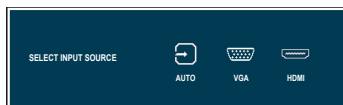

- Signal Select: Press the AUTO button when the Menu is not displayed, it shows following Menu. Signal select is switched by pressing the AUTO button successively.



## Direct

You can skip the Menu items and display an adjustment scale directly by using the following button operations.

- Volume: Press the + Button when the Menu is not displayed.

Adjustment Item	Problem / Option	Button to Press
Volume	Too soft Too loud	 <input type="button" value="+"/>  <input type="button" value="-"/>

- Auto Adjust: Press and hold the Auto Button for 3-4 seconds when the Menu is not displayed.

### Only Analog Input

Adjustment Item	Problem / Option	Button to Press
Auto Adjust *	Adjust Horizontal / Vertical Position, Pixel Clock and Phase automatically.	

\* For best results, use the Auto Adjust in conjunction with the adjustment pattern. See page 18 for SCREEN ADJUSTMENTS.

- Blue Light Reducer \* : Pressing and holding of the + Button for 3-4 seconds when the Menu is not displayed.  
Off : Normal  
Mode1 : Blue light is reduced.  
Mode2 : Blue light is reduced more than Mode1.  
Mode3 : Blue light is reduced more than Mode2.

\* Blue Light Reducer cannot be enabled if i-Style Color, Adv.Contrast or Color Settings colour are enabled.

- Lock Mode:

### <OSD>

Hold the MENU button and turn on the monitor when the monitor is power-off, it will lock/unlock the OSD Key Lock function.

### <Power/OSD>

Pressing and holding the MENU button for 10 seconds when Menu is not displayed, will lock/unlock the Power/OSD Key Lock function.

## SCREEN ADJUSTMENTS

Adjust the image by following the procedure below to get the desired picture when selecting Analog input.

- The screen adjustments described in this manual are designed to set image position and minimize flicker or blur for the particular computer in use.
- The monitor is designed to provide the best performance at resolution of 1920 × 1080, but can not provide the best at resolutions of less than 1920 × 1080 because the picture is automatically stretched to fit the full screen. It is recommended to operate at resolution of 1920 × 1080 in normal use.
- Displayed text or lines will be blurred or irregular in thickness when the picture is stretched due to the screen enlargement process.
- It is preferable to adjust the image position and frequency with the monitor controls, rather than the computer software or utilities.
- Perform adjustments after a warm-up period of at least thirty minutes.
- Additional adjustments may be required after the Auto Adjust depending on the resolution or signal timing.
- The Auto Adjust may not work correctly when displaying the picture other than the screen adjustment pattern. In this case, manual adjustments are required.

There are two ways to adjust the screen. One way is automatic adjustment for H/V-POSITION, H-SIZE and FINE. The other way is performing each adjustment manually.

Perform the Auto Adjust first when the monitor is connected to a new computer, or resolution is changed. If the screen has a flicker or blur, or the picture does not fit in the display area after performing the Auto Adjust, manual adjustments are required. Both adjustments should be made by using the screen adjustment pattern (Test.bmp) obtained via the Iiyama web site (<http://www.iiyama.com>).

Adjust the image by following the procedure below to get the desired picture.

This manual explains adjustment under Windows® OS.

- ① **Display the picture at the optimum resolution.**
- ② **Enter the Test.bmp (screen adjustment pattern) to wallpaper.**

- NOTE**
- Consult the appropriate documentation for doing this.
  - Set the display position to center in the wallpaper setting dialogue box.

[Adjustment pattern]

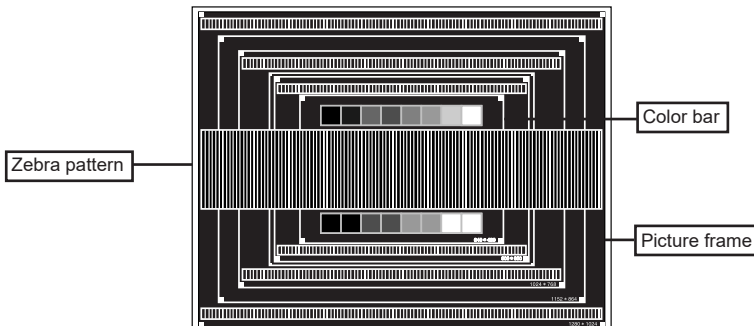

- ③ Press and hold the Auto Button for 3-4 seconds when the Menu is not displayed. (AUTO ADJUST)
- ④ Adjust the image manually by following procedure below when the screen has a flicker or blur, or the picture does not fit in the display area after performing the Auto Adjust.
- ⑤ Adjust the V-POSITION so that the top and bottom of the picture frame will fit to the display area.

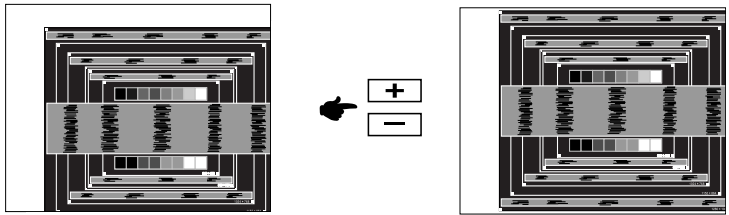

- ⑥ 1) Adjust the H-POSITION so that the left side of the picture frame will move to the left edge of the display area.

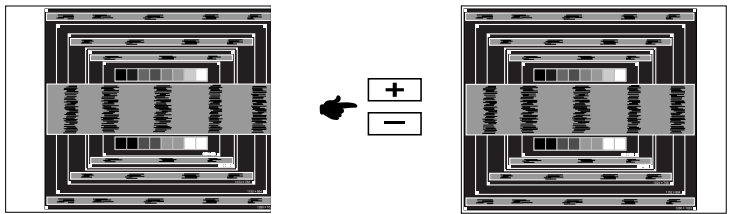

- 2) Stretch the right side of the picture frame to the right edge of the display area by adjusting the H-SIZE.

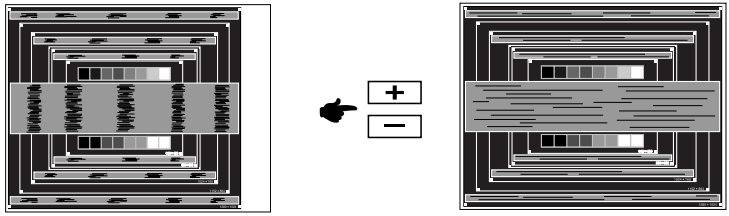

**NOTE**

- When the left side of the picture frame moves apart from the left edge of the display area during the H-SIZE adjustment, adjust steps 1) and 2).
- Another way to make the H-SIZE adjustment is to correct the vertical wavy lines in the zebra pattern.
- The picture may flicker during the H-SIZE, H/V-POSITION adjustment.
- In case the picture frame is bigger or smaller than the data display area after the H-SIZE adjustment, repeat steps from ③.

- ⑦ Adjust the FINE to correct horizontal wavy noise, flicker or blur in the zebra pattern.

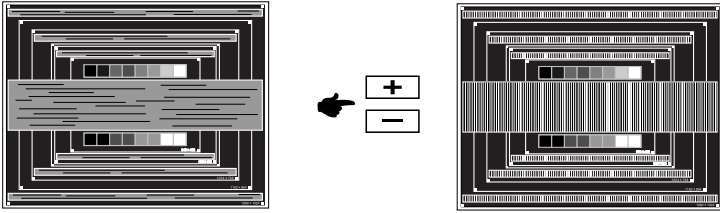

**NOTE**

- In case the strong flicker or blurs remain on a part of the screen, repeat steps ⑥ and ⑦ because the H-SIZE may not be adjusted correctly.
  - Adjust the H-POSITION after the FINE adjustment if the horizontal position moves during the adjustment.
- ⑧ Adjust the Brightness and Color to get the desired picture after you complete the H-SIZE and FINE adjustments.
- Put back your favorite wallpaper.



## STANDBY FEATURE

This product features the standby function. When activated, it automatically reduces unnecessary power consumption of the monitor when your computer is not in use.

There is a standby step the monitor takes as described below. The standby function, including any timer settings is configured by the operating system. Check your operating system manual for information on how this can be configured.

### ■ Standby Mode

When the video signal from the computer is off, the monitor enters into Standby Mode which reduces the power consumption to less than 0.5W\*. The screen becomes dark, and the power indicator turns to orange. From Standby Mode, the image reappears in several seconds when either the keyboard or the mouse are touched again.

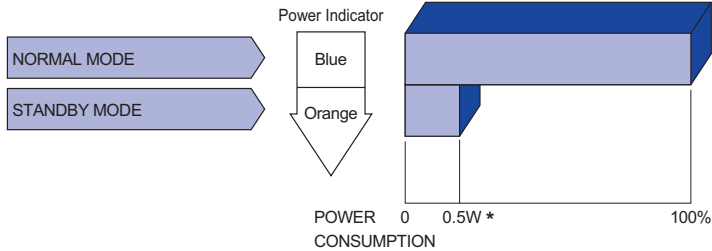

\* When the USB devices are not connected.

# TROUBLE SHOOTING

If the monitor fails to operate correctly, please follow the steps below for a possible solution.

1. Perform the adjustments described in OPERATING THE MONITOR, depending on the problem you have. If the monitor does not get a picture, skip to 2.
2. Consult the following items if you cannot find an appropriate adjustment item in OPERATING THE MONITOR or if the problem persists.
3. If you are experiencing a problem which is not described below or you cannot correct the problem, discontinue using the monitor and contact your dealer or iiyama service center for further assistance.

<b>Problem</b>	<b>Check</b>
① The picture does not appear. (Power indicator does not light up.)  (Power indicator is blue.)  (Power indicator is orange.)	<input type="checkbox"/> The Power Cable is firmly seated in the socket. <input type="checkbox"/> The Power Switch is turned ON. <input type="checkbox"/> The AC socket is live. Please check with another piece of equipment.  <input type="checkbox"/> If the blank screen saver is in active mode, touch the keyboard or the mouse. <input type="checkbox"/> Increase the Contrast and/or Brightness. <input type="checkbox"/> The computer is ON. <input type="checkbox"/> The Signal Cable is properly connected. <input type="checkbox"/> The signal timing of the computer is within the specification of the monitor.  <input type="checkbox"/> If the monitor is in standby mode, touch the keyboard or the mouse. <input type="checkbox"/> The computer is ON. <input type="checkbox"/> The Signal Cable is properly connected. <input type="checkbox"/> The signal timing of the computer is within the specification of the monitor.
② The screen is not synchronized.	<input type="checkbox"/> The Signal Cable is properly connected. <input type="checkbox"/> The signal timing of the computer is within the specification of the monitor.
③ The screen position is not in the center.	<input type="checkbox"/> The signal timing of the computer is within the specification of the monitor.
④ The screen is too bright or too dark.	<input type="checkbox"/> The video output level of the computer is within the specification of the monitor.
⑤ The screen is shaking.	<input type="checkbox"/> The power voltage is within the specification of the monitor. <input type="checkbox"/> The signal timing of the computer is within the specification of the monitor.
⑥ No sound.	<input type="checkbox"/> The audio equipment (computer etc.) is ON. <input type="checkbox"/> The Audio Cable is properly connected. <input type="checkbox"/> The Volume is turned up. <input type="checkbox"/> The Mute is OFF. <input type="checkbox"/> The audio output level of the audio equipment is within the specification of the monitor.
⑦ The sound is too loud or too quiet.	<input type="checkbox"/> The audio output level of the audio equipment is within the specification of the monitor.

## Problem

## Check

- |  |   |
|--|---|
| ⑧ A strange noise is heard.            | <input type="checkbox"/> The Audio Cable is properly connected.   |
| ⑨ The touch screen shows no response.  | <input type="checkbox"/> The USB Cable is firmly seated in the socket.<br><input type="checkbox"/> Touch screen driver software is installed. |
| ⑩ The touch position does not deviate. | <input type="checkbox"/> The calibration function set up correctly.   |

## RECYCLING INFORMATION

For better environment protection please don't dispose your monitor.  
Please visit our web site: [www.iiyama.com](http://www.iiyama.com) for monitor recycling.

# APPENDIX

Design and specifications are subject to change without prior notice.

## SPECIFICATIONS

Touch Screen	Technology	Projected capacitive 10pt touch
	Communication system	USB
Size Category		24"
LCD Panel	Panel technology	IPS
	Size	Diagonal: 23.8" (60.47cm)
	Pixel pitch	0.2745mm H × 0.2745mm V
	Brightness	250cd/m <sup>2</sup> (Typical)
	Contrast ratio	1000 : 1 (Typical: with Touch Panel)
	Viewable angle	Horizontal : 178 degrees, Vertical: 178 degrees (Typical)
	Response time	4ms (Gray to Gray)
Display Colors		Approx.16.7M
Sync Frequency		Analog: Horizontal: 30.0-80.0kHz, Vertical: 56-75Hz Digital: Horizontal: 30.0-80.0kHz, Vertical: 56-75Hz
Native Resolution		1920 × 1080, 2.1 MegaPixels
Support max. resolution		VGA: 1920 × 1080 60Hz HDMI: 1920 × 1080 60Hz
Input Connector		VGA, HDMI
Input Sync Signal		Separate sync: TTL, Positive or Negative
Input Video Signal		Analog: 0.7Vp-p (Standard), 75Ω, Positive Digital: HDMI
USB Standard		USB3.0 (DC5V, 900mA)
Number of USB Ports		1 Upstream : Series B
Connector shape		2 Downstream : Series A
Input Audio Connector		ø 3.5mm mini jack (Stereo)
Input Audio Signal		0.5Vrms maximum
Speakers		2W × 2 (Stereo speakers)
Maximum Screen Size		527.04mm W × 296.46mm H / 20.7" W × 11.7" H
Power Source		100-240VAC, 50/60Hz, 1.5A
Power Consumption*		24W typical, Standby mode: 0.5W maximum, Off mode: 0.3W maximum
Dimensions / Net Weight		540.5 × 388.0 - 128.0 × 238.5mm / 21.3 × 15.3 - 5.0 × 9.4" (W×H×D) 5.5kg / 12.1lbs
Tilt Angle		Upward: 90 degrees Downward: 5 degrees
Environmental Considerations		Operating: Temperature 5 to 35°C / 41 to 95°F Humidity 20 to 80% (No condensation) Storage: Temperature -20 to 60°C / -4 to 140°F Humidity 10 to 90% (No condensation)
Approvals		CE, UKCA, TÜV-Bauart, EAC

**NOTE** \* When the USB devices are not connected.

## DIMENSIONS

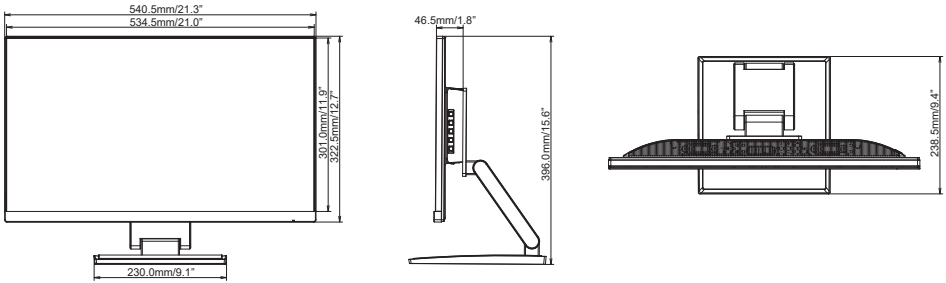

## COMPLIANT TIMING

Video Mode	Horizontal Frequency	Vertical Frequency	Dot Clock
640 × 480	31.469kHz	59.940Hz	25.175MHz
	37.500kHz	75.000Hz	31.500MHz
800 × 600	35.156kHz	56.250Hz	36.000MHz
	37.879kHz	60.317Hz	40.000MHz
	46.875kHz	75.000Hz	49.500MHz
1024 × 768	48.363kHz	60.004Hz	65.000MHz
	56.476kHz	70.069Hz	75.000MHz
	60.023kHz	75.029Hz	78.750MHz
1280 × 1024	63.981kHz	60.020Hz	108.000MHz
	79.976kHz	75.025Hz	135.000MHz
1440 × 900	55.935kHz	59.887Hz	106.500MHz
1680 × 1050	65.290kHz	59.954Hz	146.250MHz
1920 × 1080	67.500kHz	60.000Hz	148.500MHz